

Modelação Geométrica e Generativa



UNIVERSIDADE
DE LISBOA



FACULDADE DE ARQUITETURA
UNIVERSIDADE DE LISBOA

Mestrado Integrado em Arquitectura
Ano Lectivo 2022-2023 1º Semestre
Docente - Nuno Alão 4º Ano

20181177



LUÍS FILIPE AFONSO GUIA

U LISBOA

UNIVERSIDADE
DE LISBOA

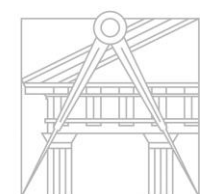

FACULDADE DE ARQUITETURA
UNIVERSIDADE DE LISBOA

MGeG

Mestrado Integrado em Arquitectura
Ano Lectivo 2022-2023 1º Semestre
Docente - Nuno Alão 4º Ano

ÍNDICE

1.1 QGIS

- 1.1.1 - Representação dos Mapas
- 1.1.2 – Exportação para o Autocad

2 - Rhinoceros Software 3D

- 2.1 - Dodecaedro Truncado
- 2.2 - Dual Dodecaedro Truncado

3 – Conchas

- 3.1 – Spirula
- 3.2 – Planorbis
- 3.3 – Nautius
- 3.4 – Caracol

3 – Conchas

- 3.1 – Spirula
- 3.2 – Planorbis
- 3.3 – Nautius
- 3.5 – Elipse Invertida em Caramujo

4 – Cubo Fragmentado

5- Terrenos

- 5.1 – Terreno Hipotetico
- 5.2 – Terrenos
- 5.3- Terreno de Intervenção

6.0- Conchas Bivalves

- 6.1- Mexilhão
- 6.2- Ameijoa
- 6.3 – Vieira
- 6.4 – Ostra/ Perola

7.0- Corais

- 7.1 - Coral Espinhoso
- 7.2- Coral Octopussy
- 7.3 – Coral 3
- 7.4 – Coral 4

8.0- Anemonas

9.0 Abobadas

- 9.1- Abobada de Berço
- 9.2 – Abobada de Cisterna
- 9.3 – Abobada de Ogiva
- 9.4 – Abobada Abatida
- 9.5 – Abobada Cilíndrica
- 9.6 – Luneta Esferica
- 9.7 – Luneta Cónica
- 9.8 – Abobada Torica
- 9.9 – Abobada Helicoidal



Exerc. 1.1 – QGIS

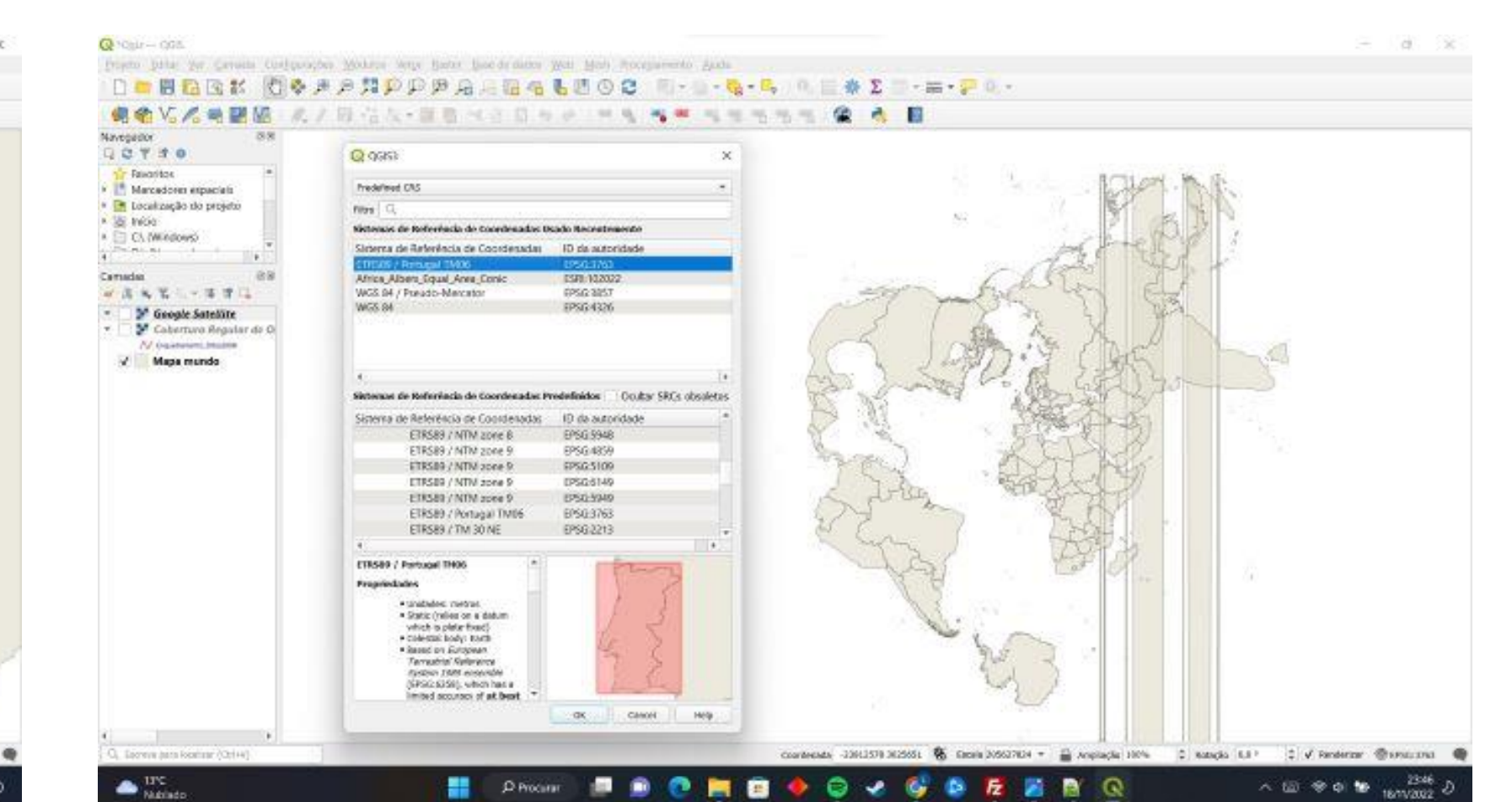
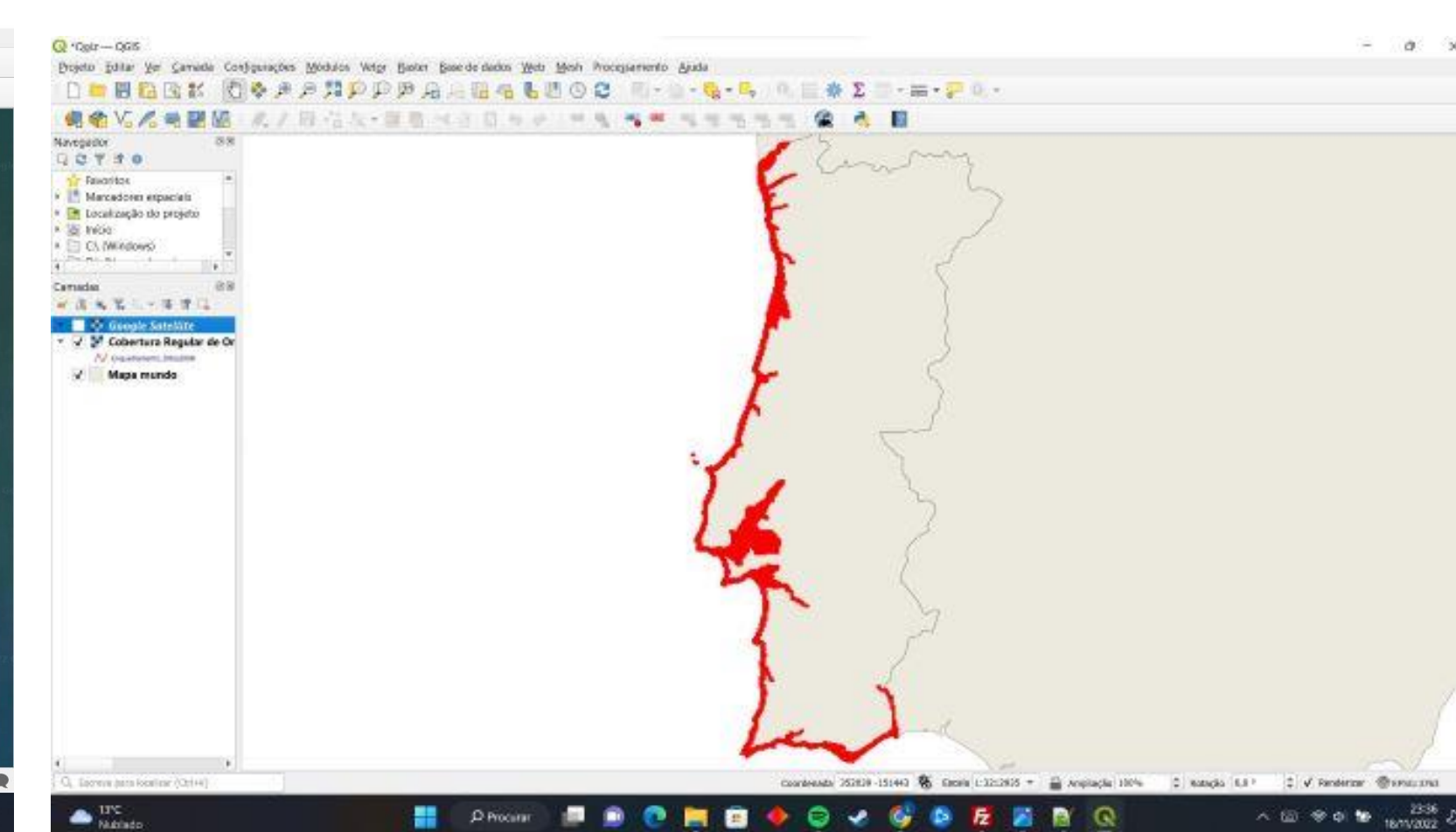
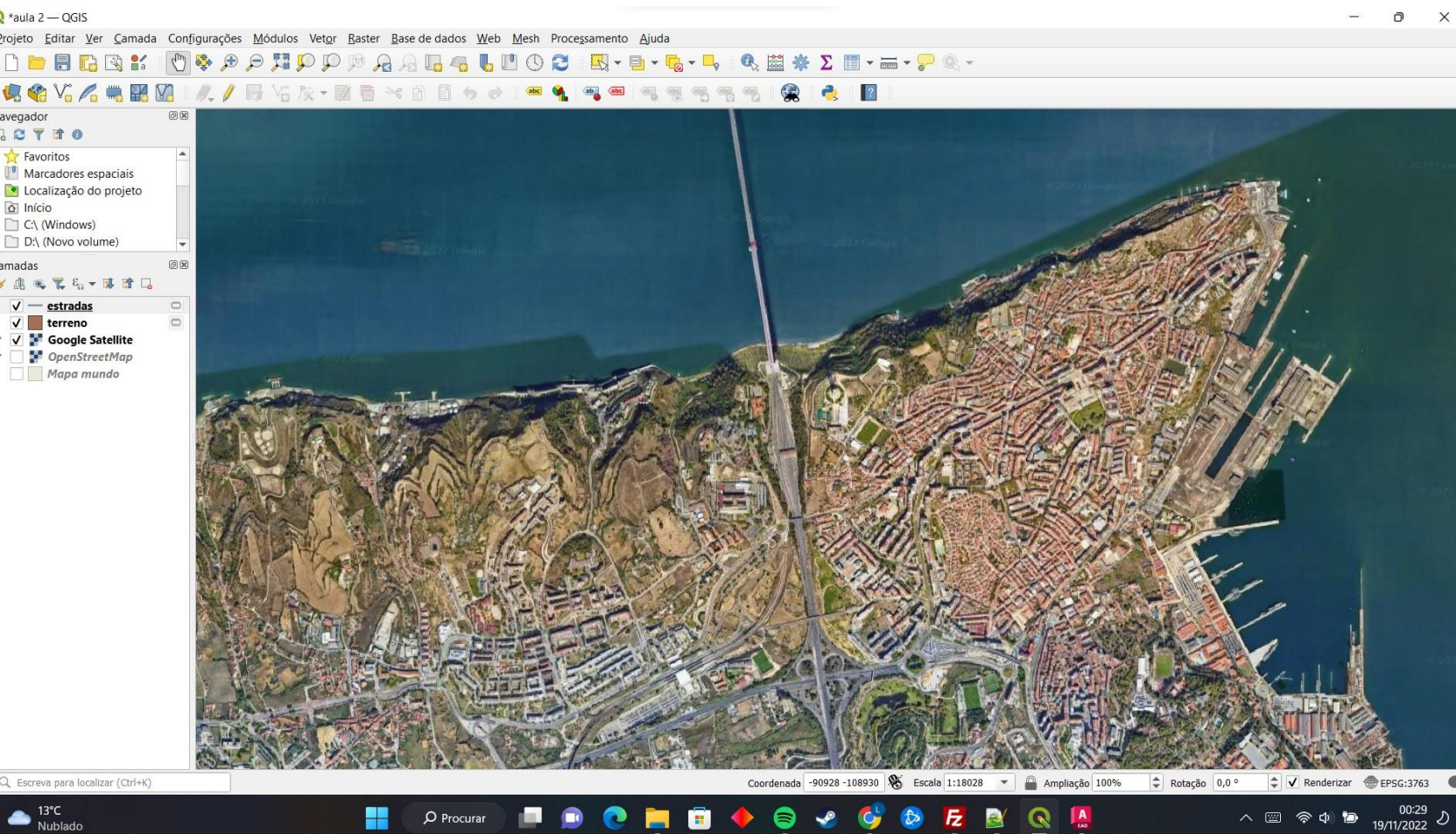
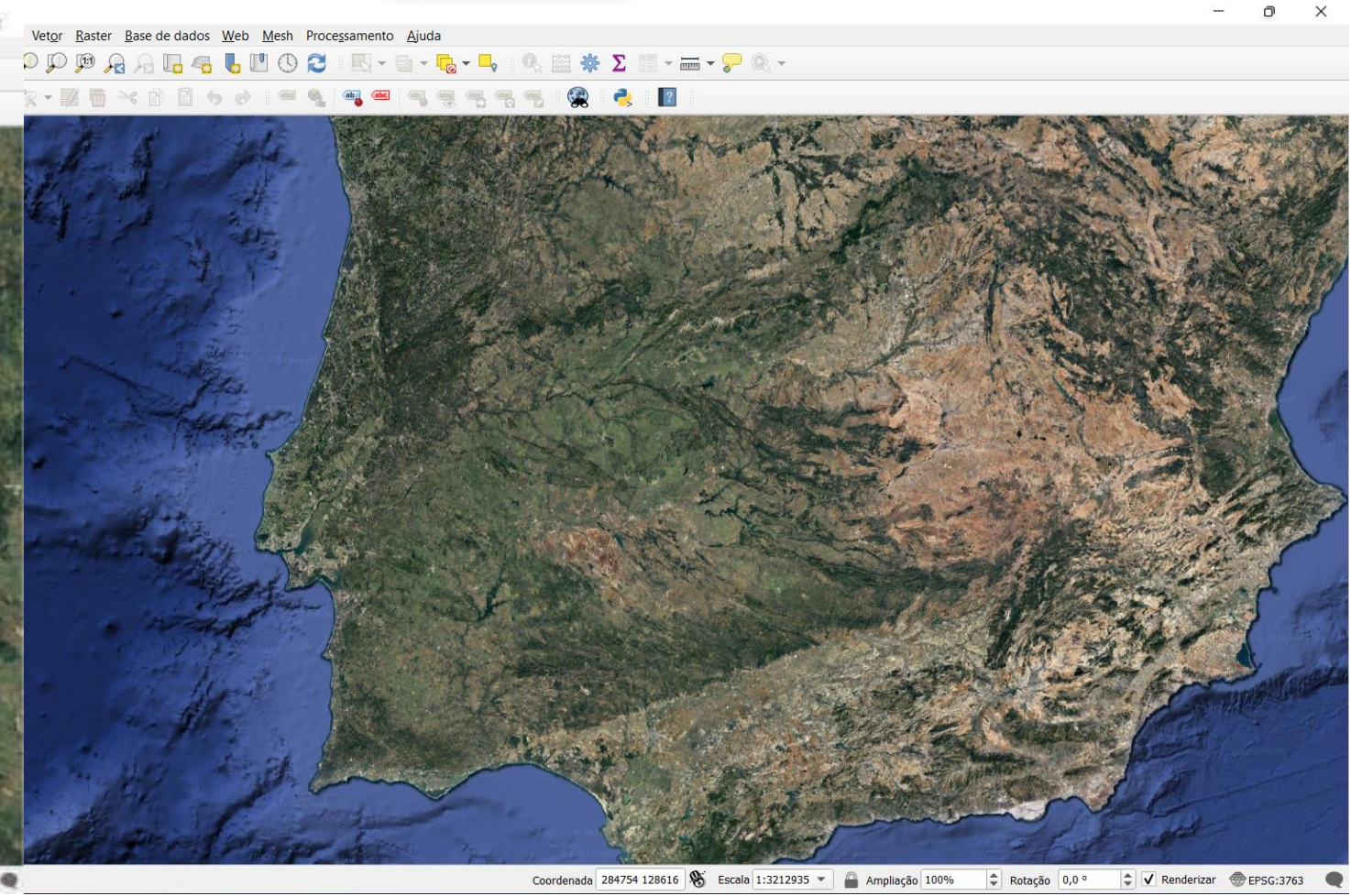
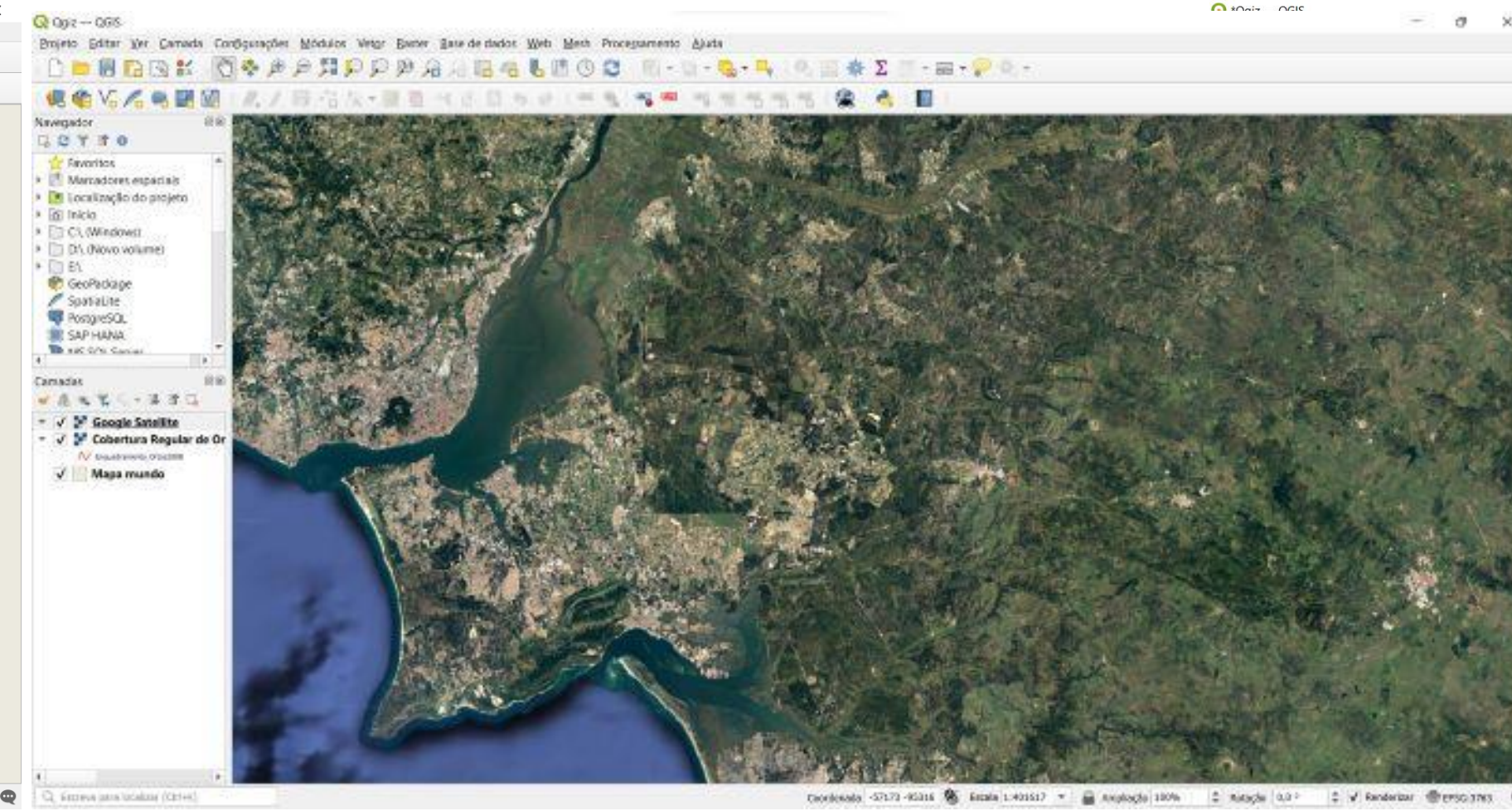
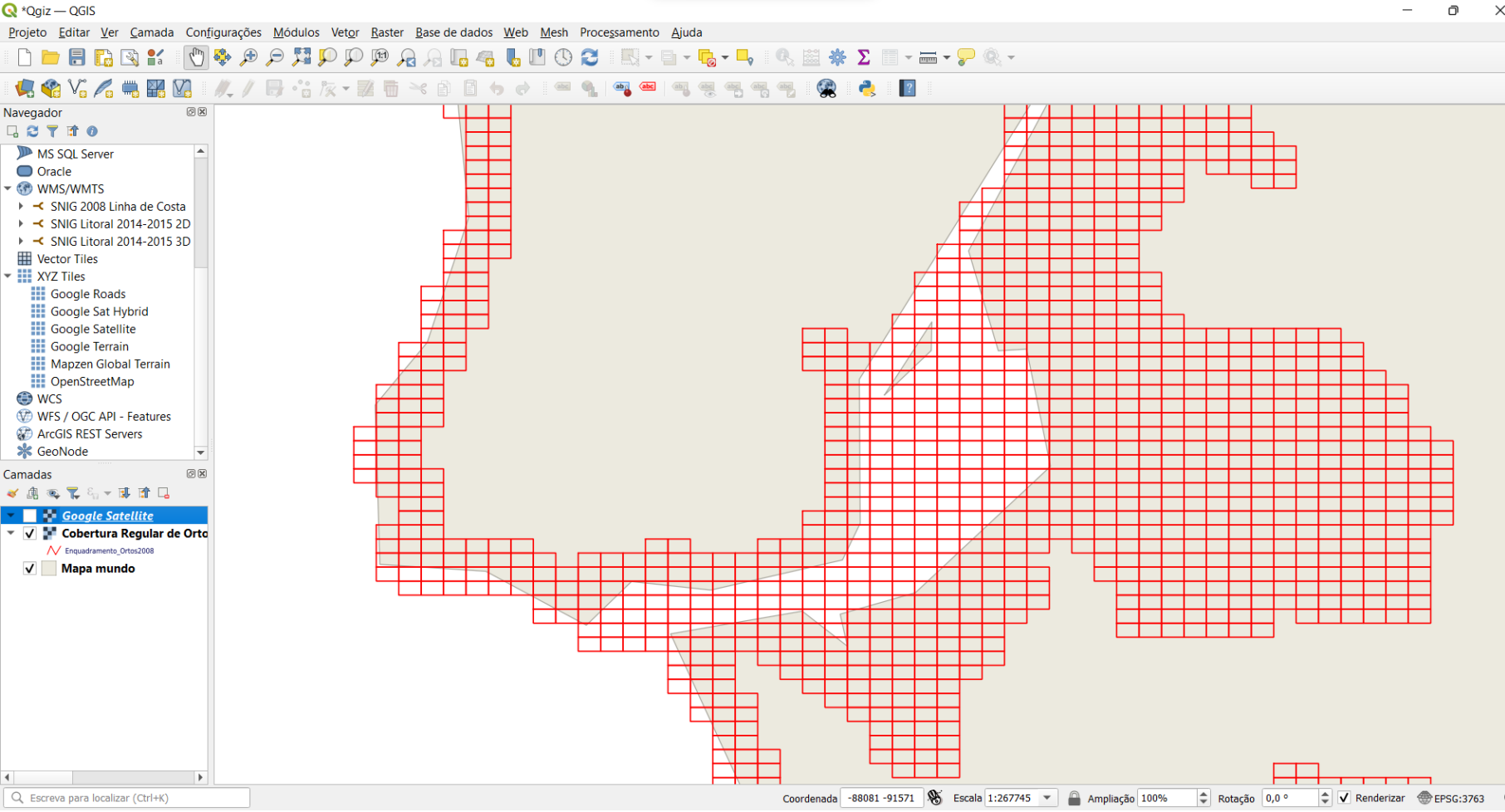

Exerc. 1.1.1 - QGIS

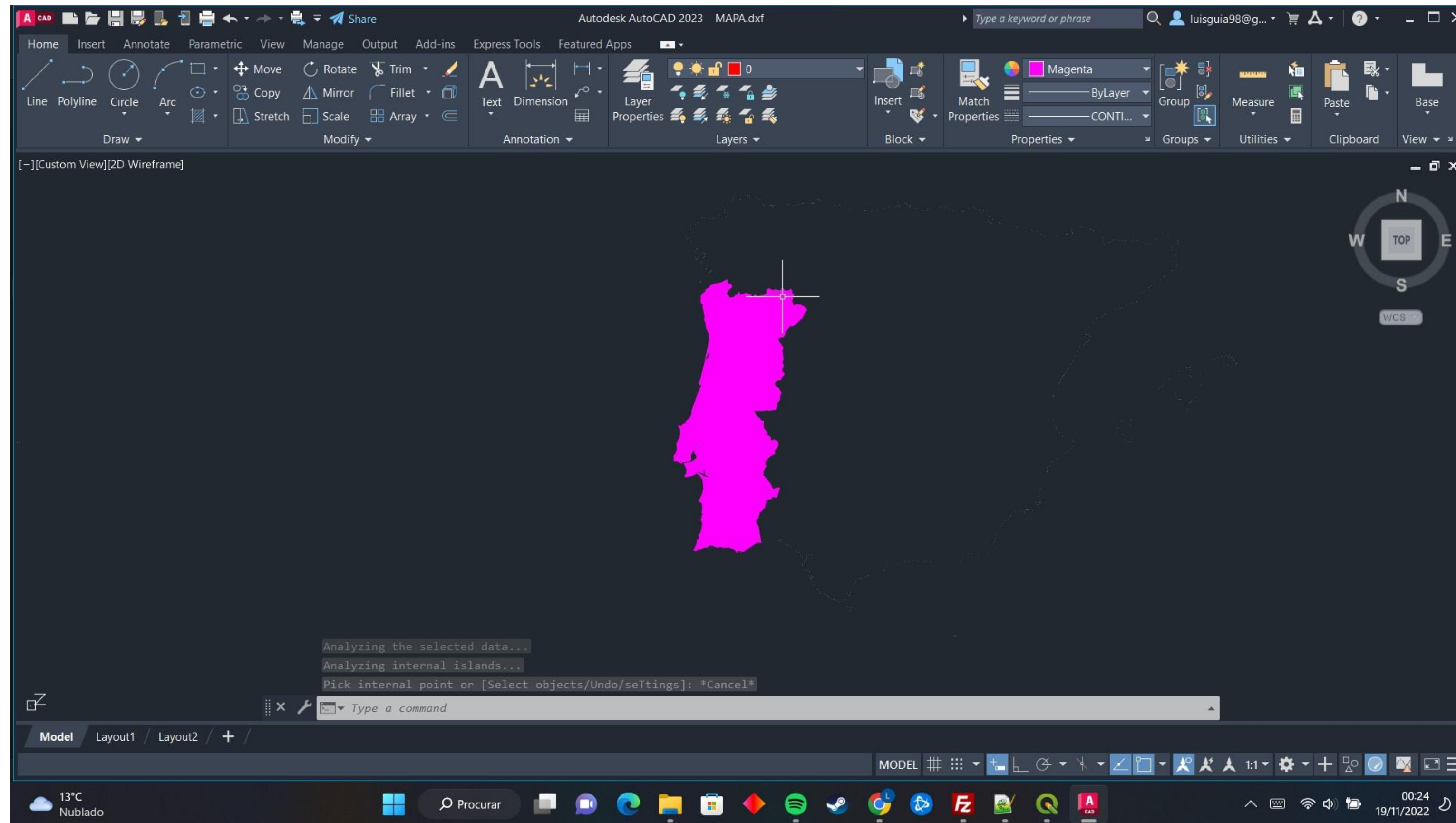

Exerc. 1.1.2 - QGIS



Exerc. 2 - Rhino

Exerc. 2.1 - POLIEDROS

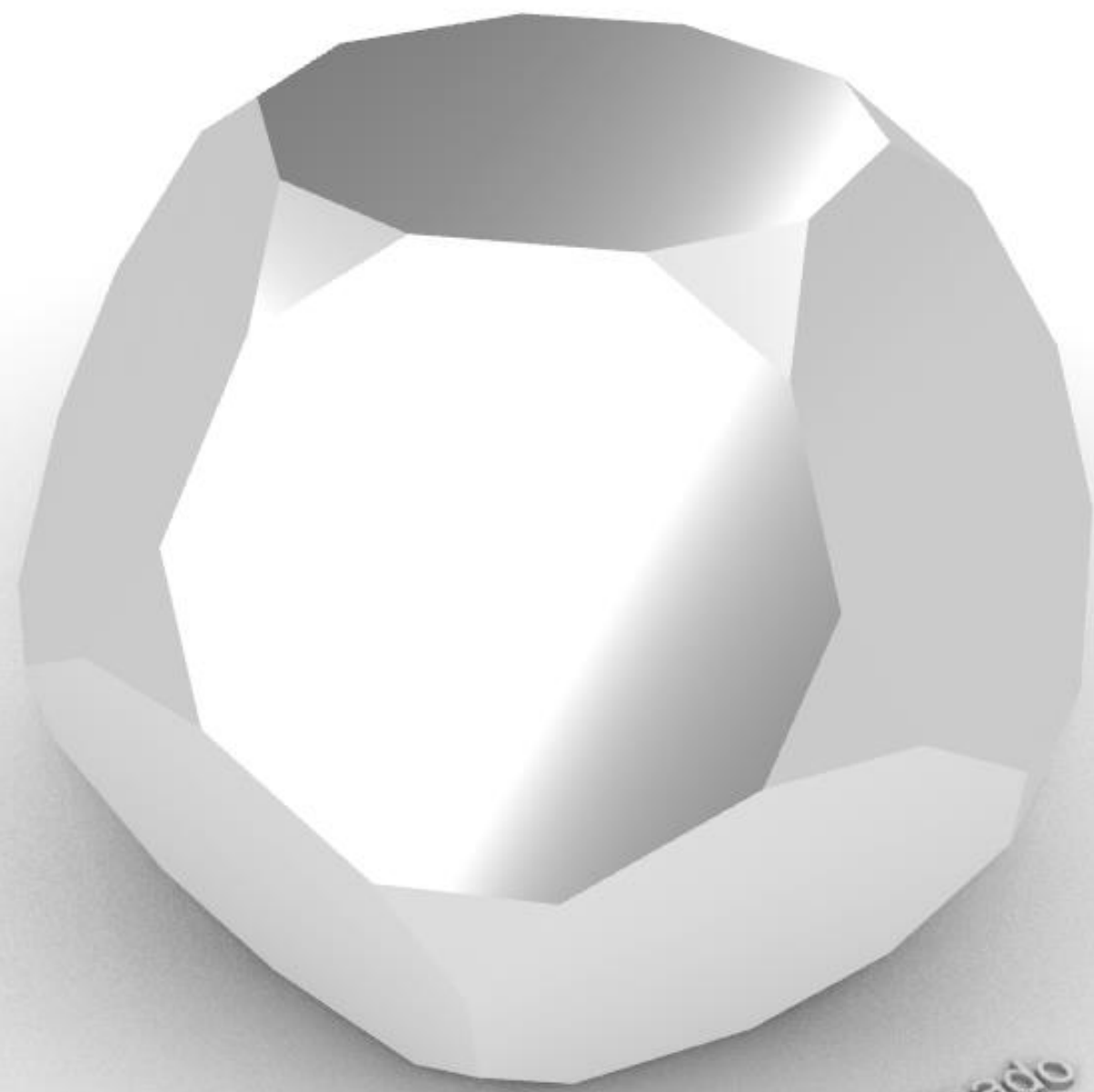

Dodecaedro Truncado

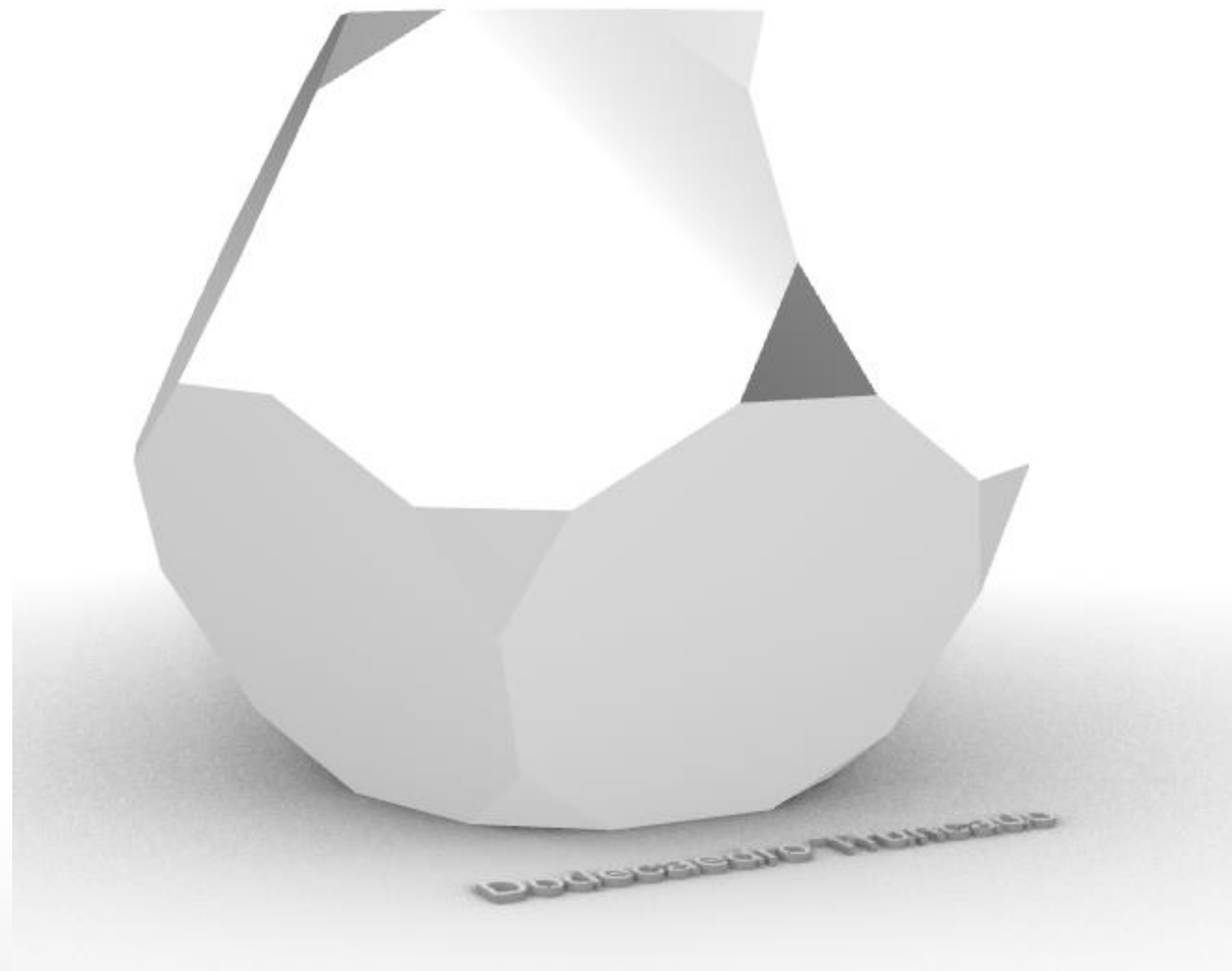

Dodecaedro Truncado

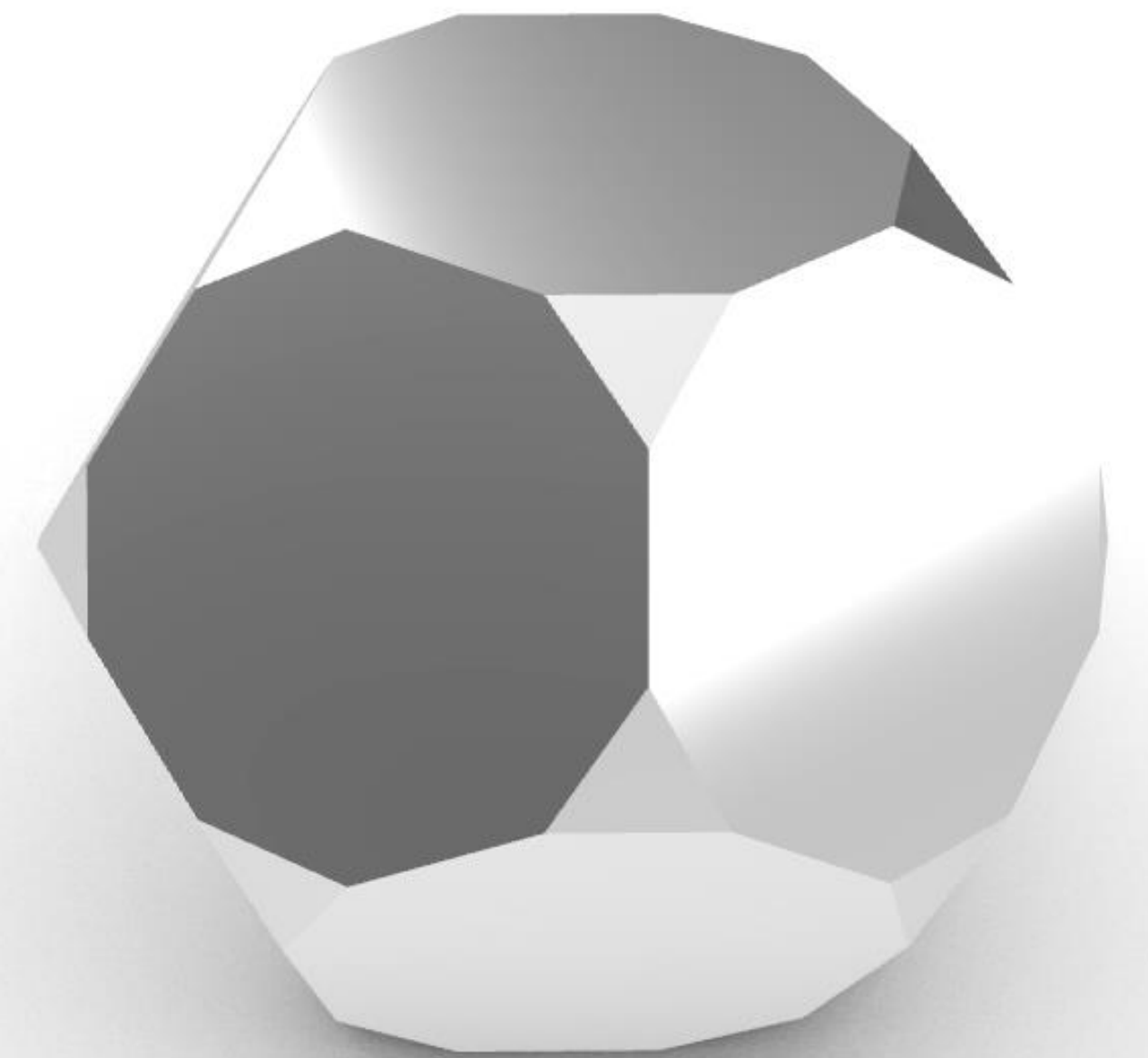

Exerc. 2.1 –Dodecaedro Truncado

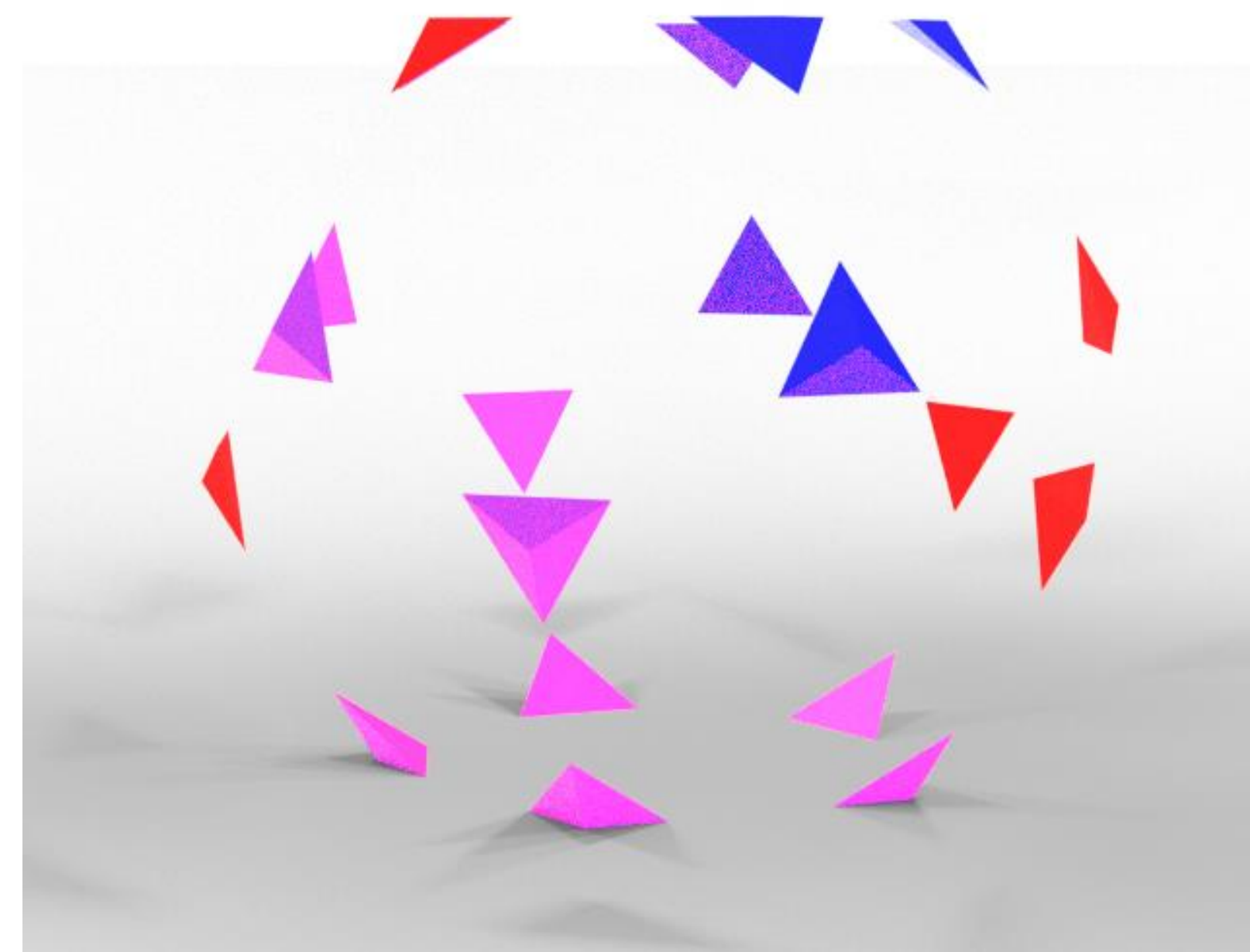
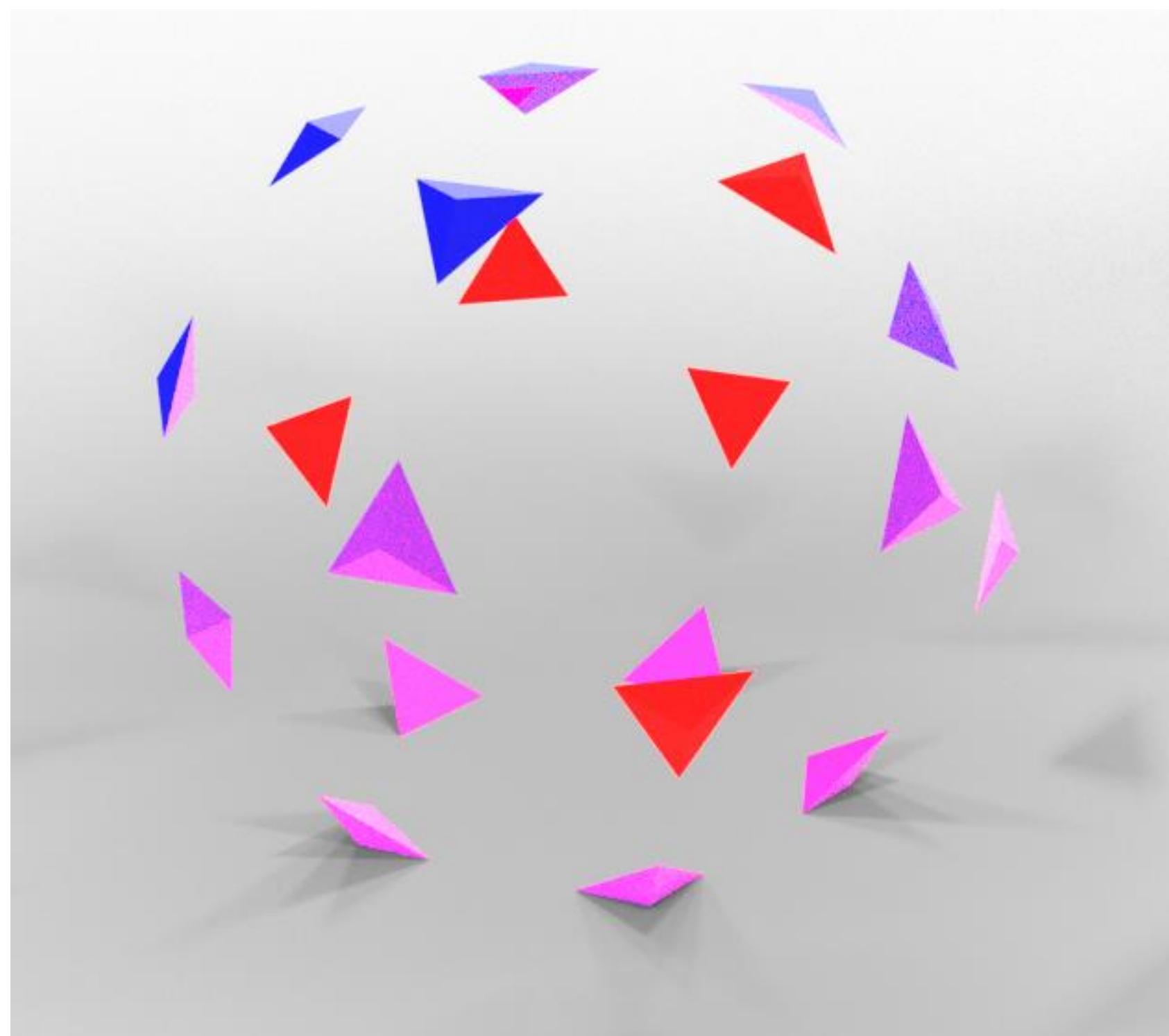
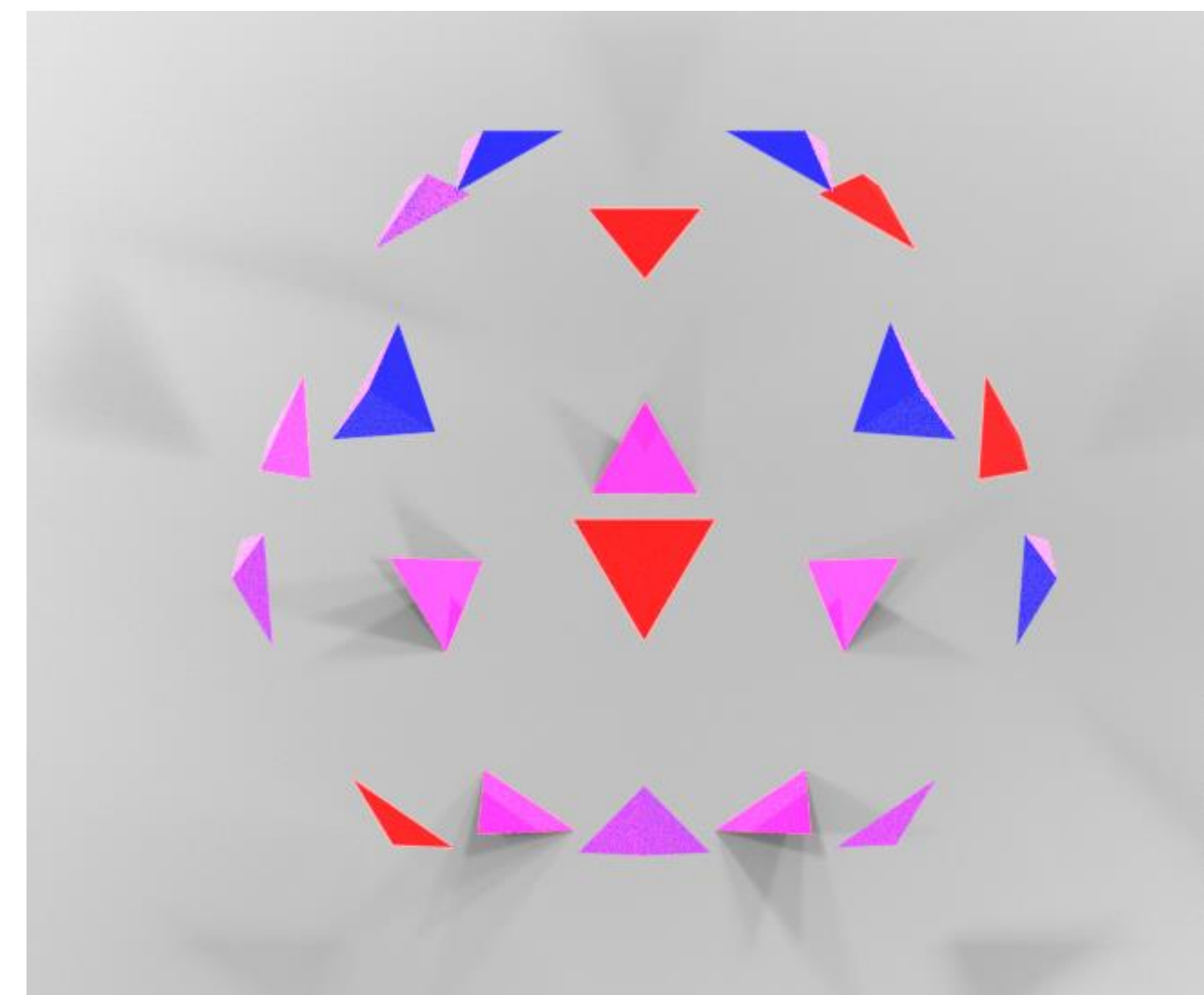

Exerc. 2.1 –

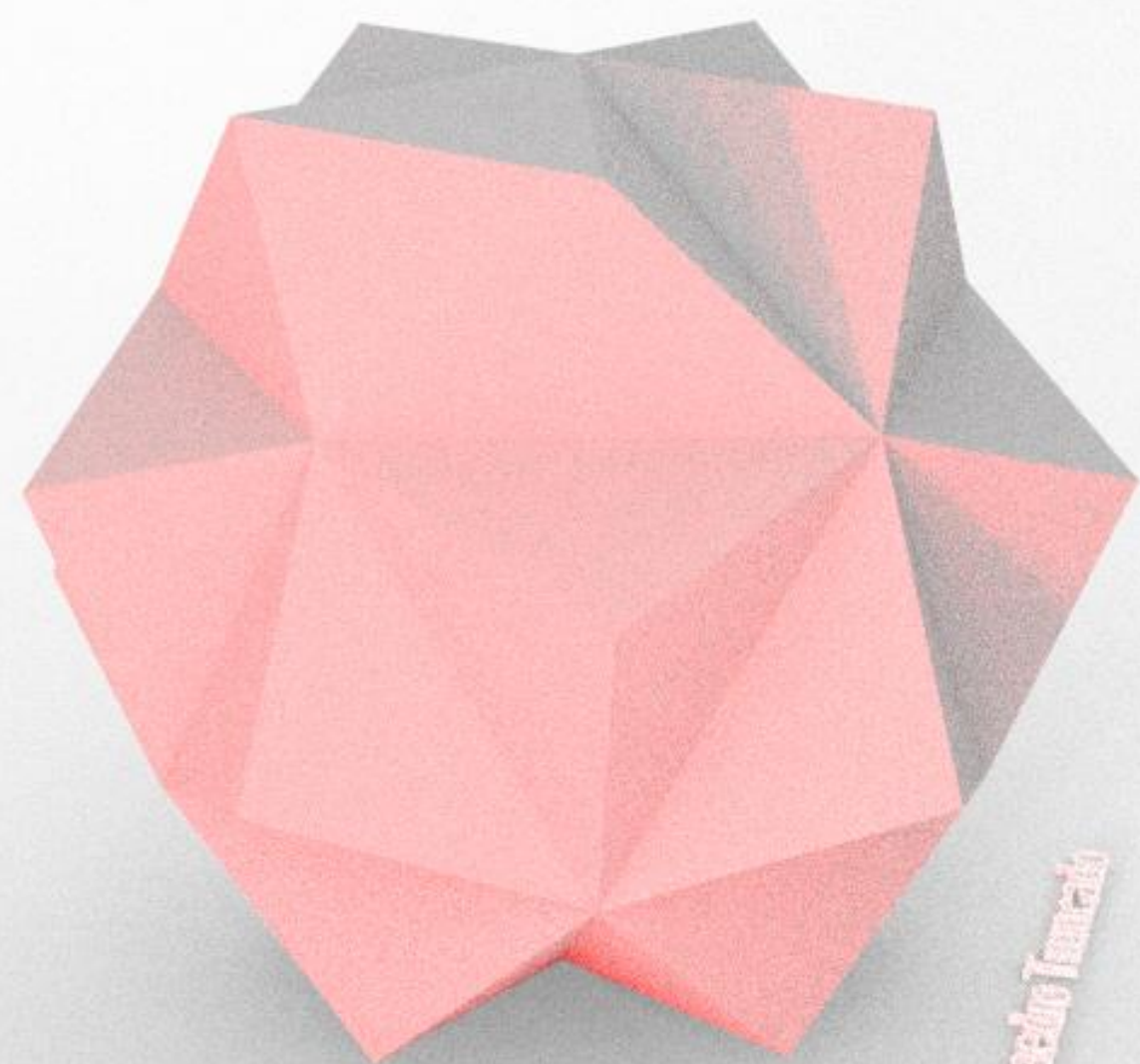

Dual do Dodecaedro Truncado

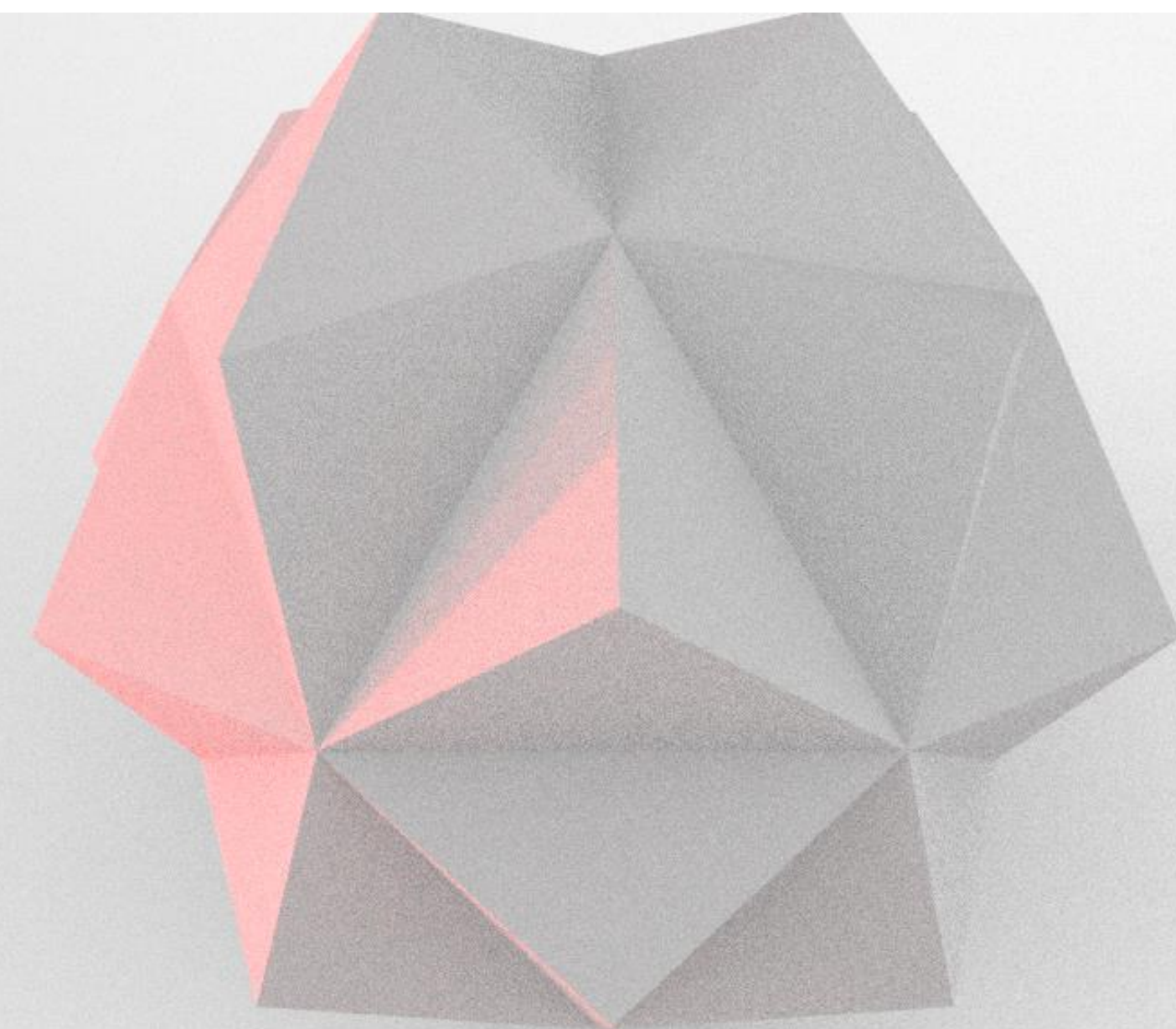
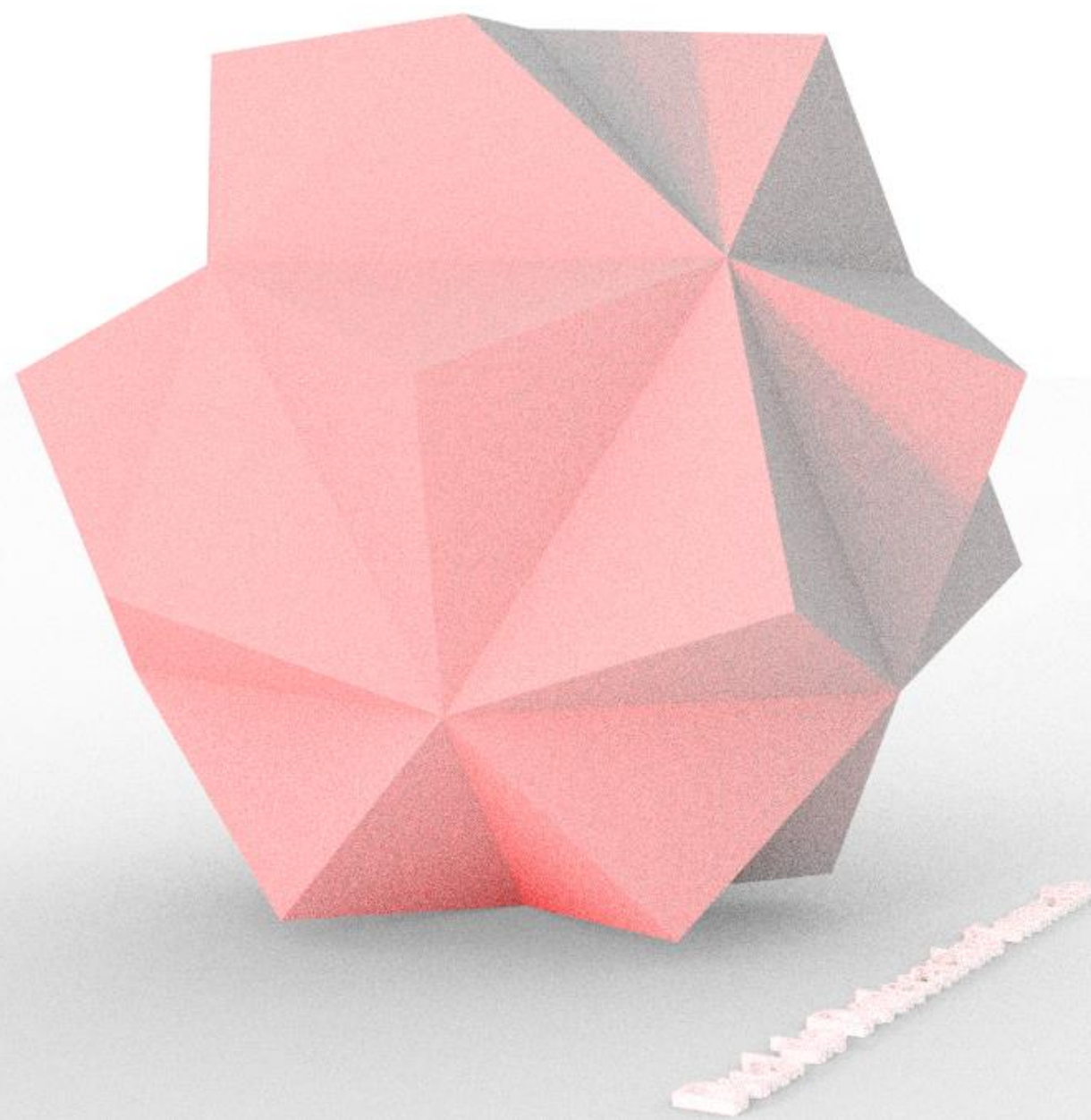

Dual do Dodecaedro Truncado

Exerc. 2.2 – Dual Dodecaedro Truncado



Exerc. 3.1 - Spirula

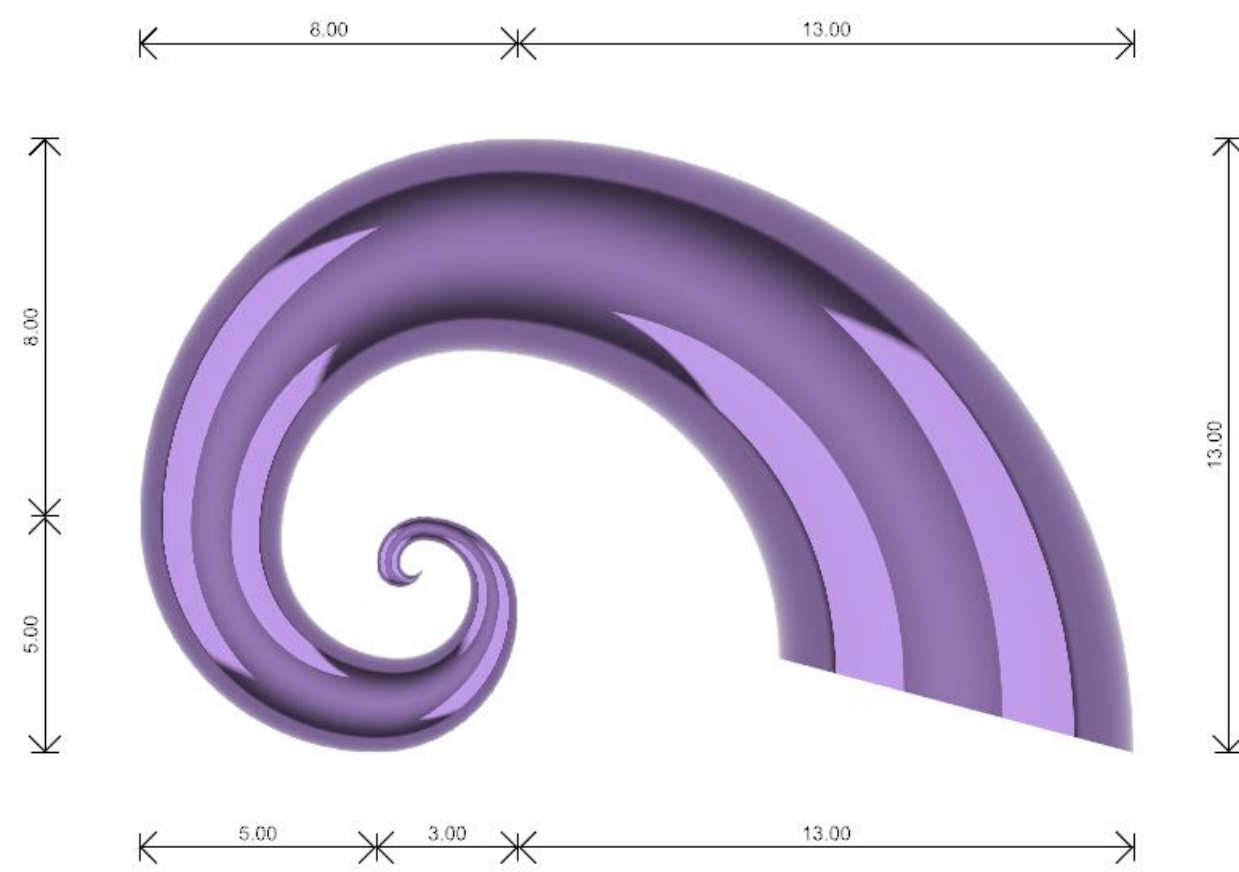

Spirula

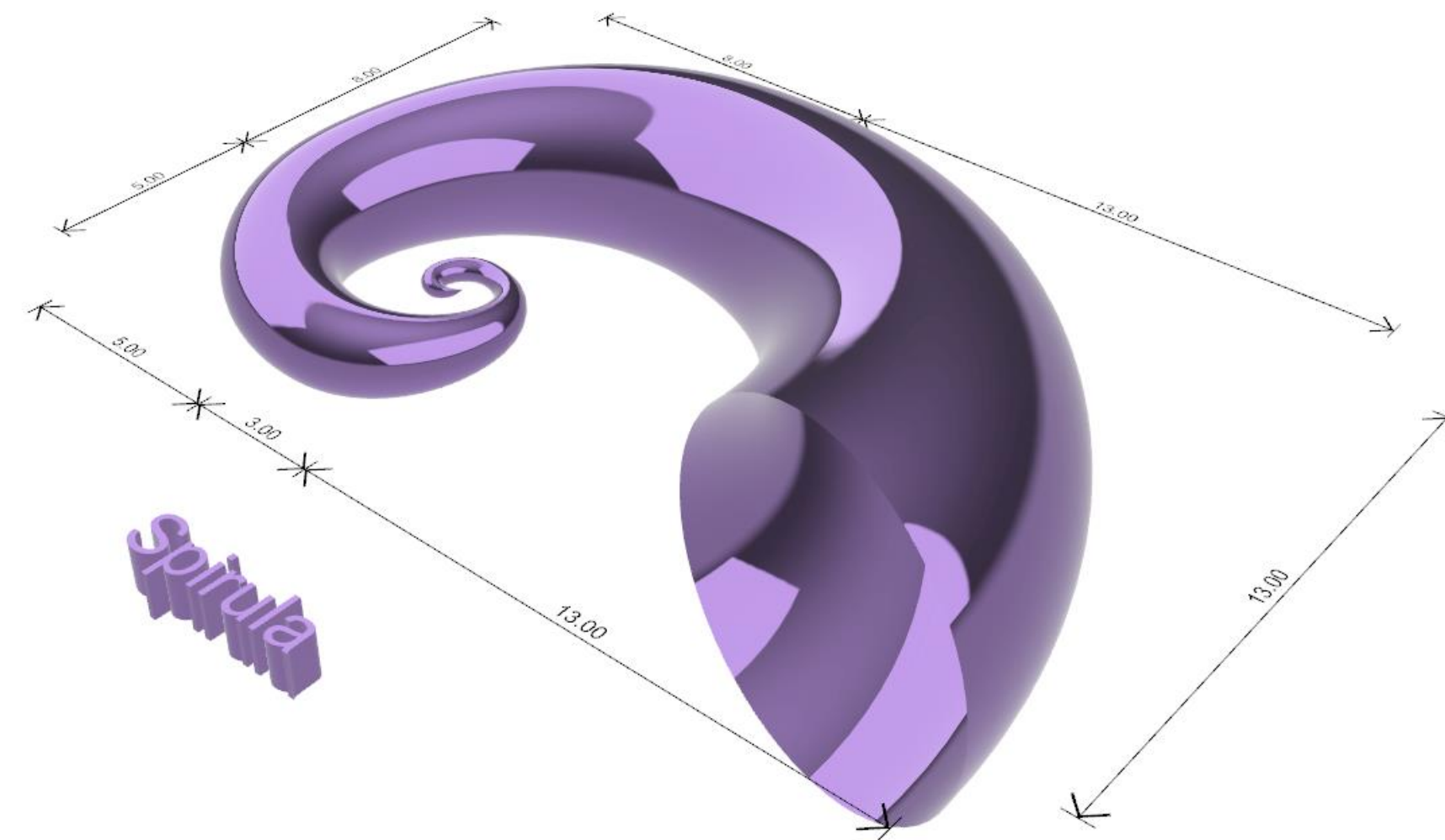

Spirula

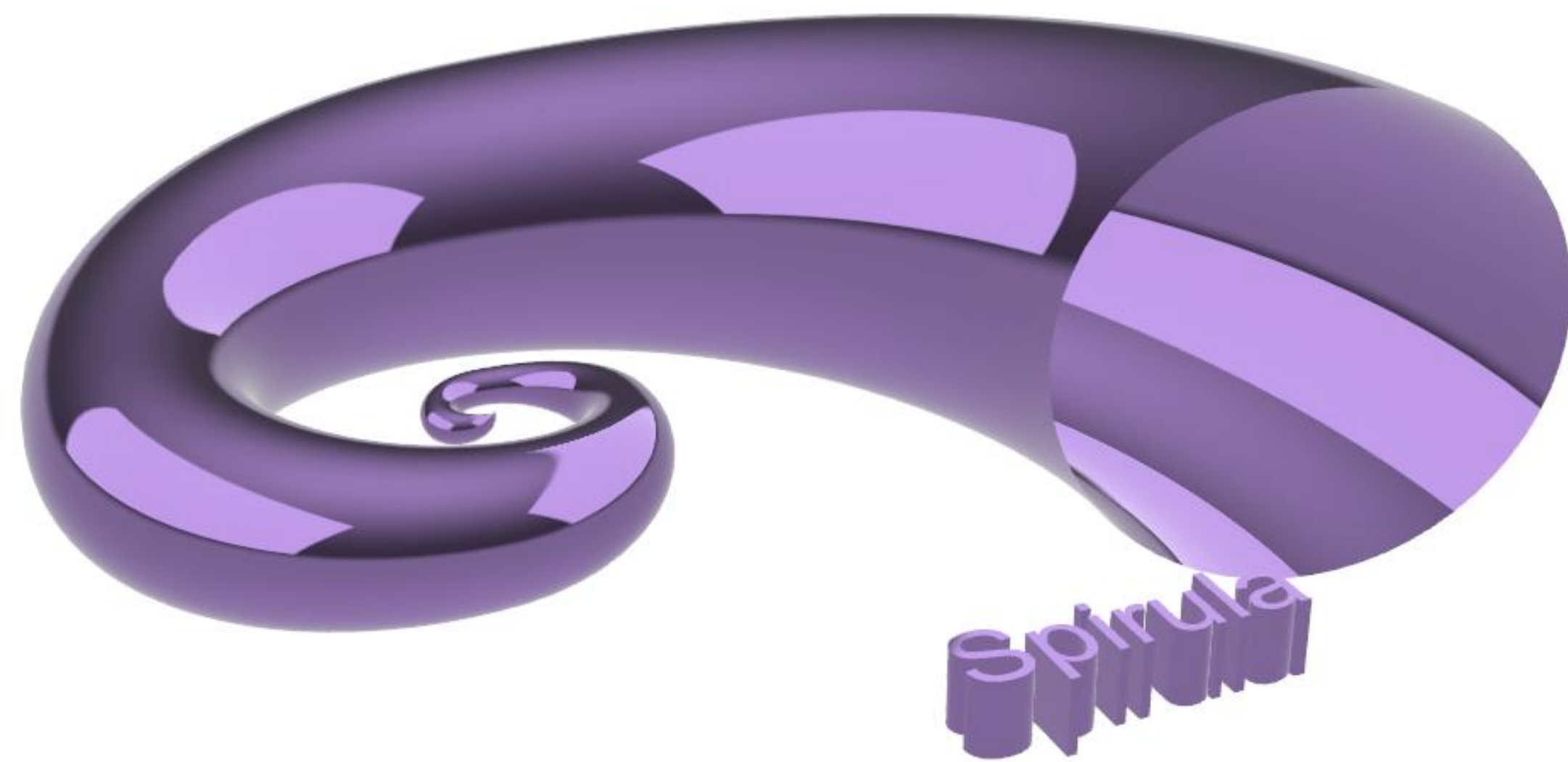

Spirula

Exerc. 3.1 - Spirula



Exerc. 3.2 - Planorbis

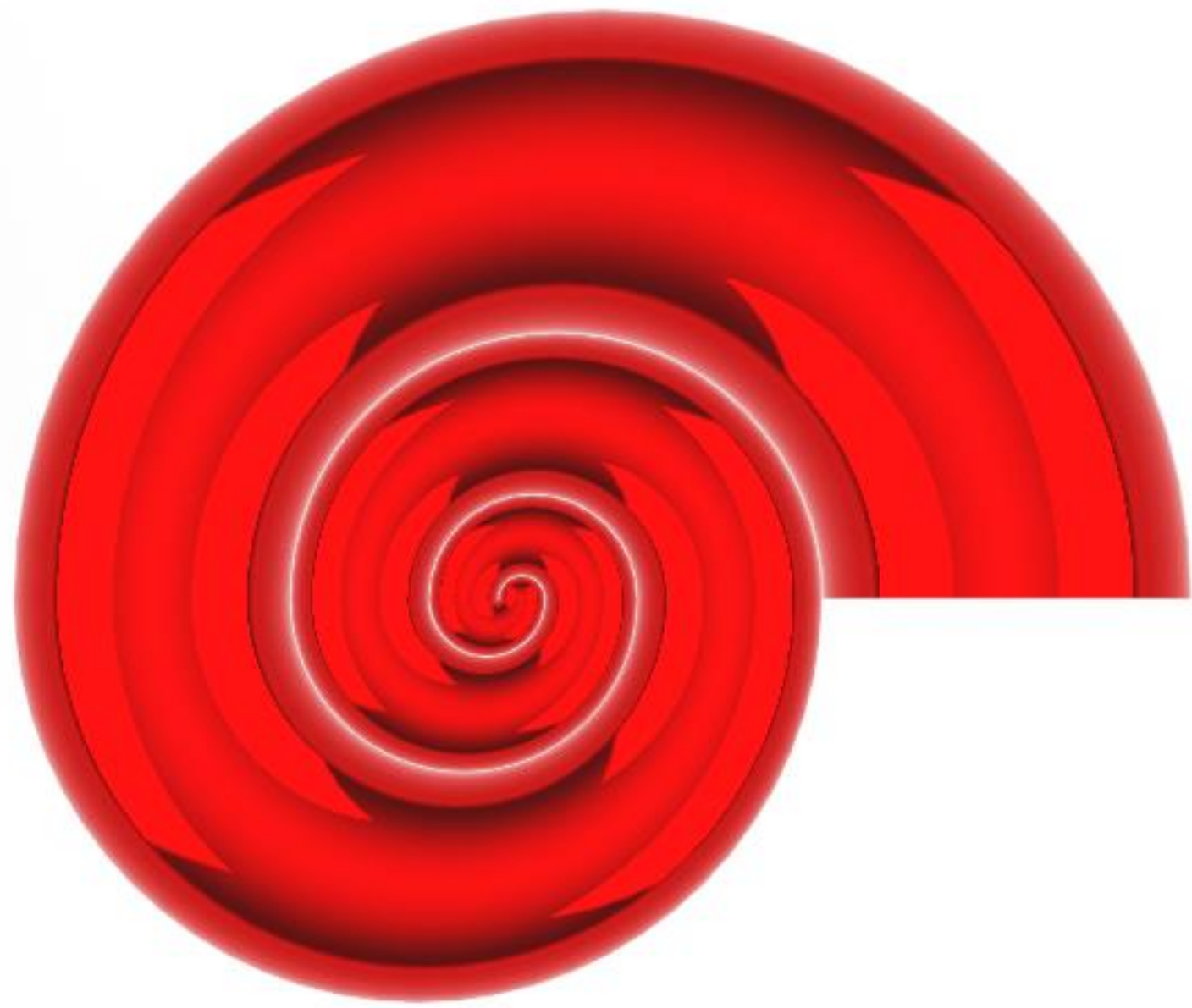

Planorbis



Planorbis

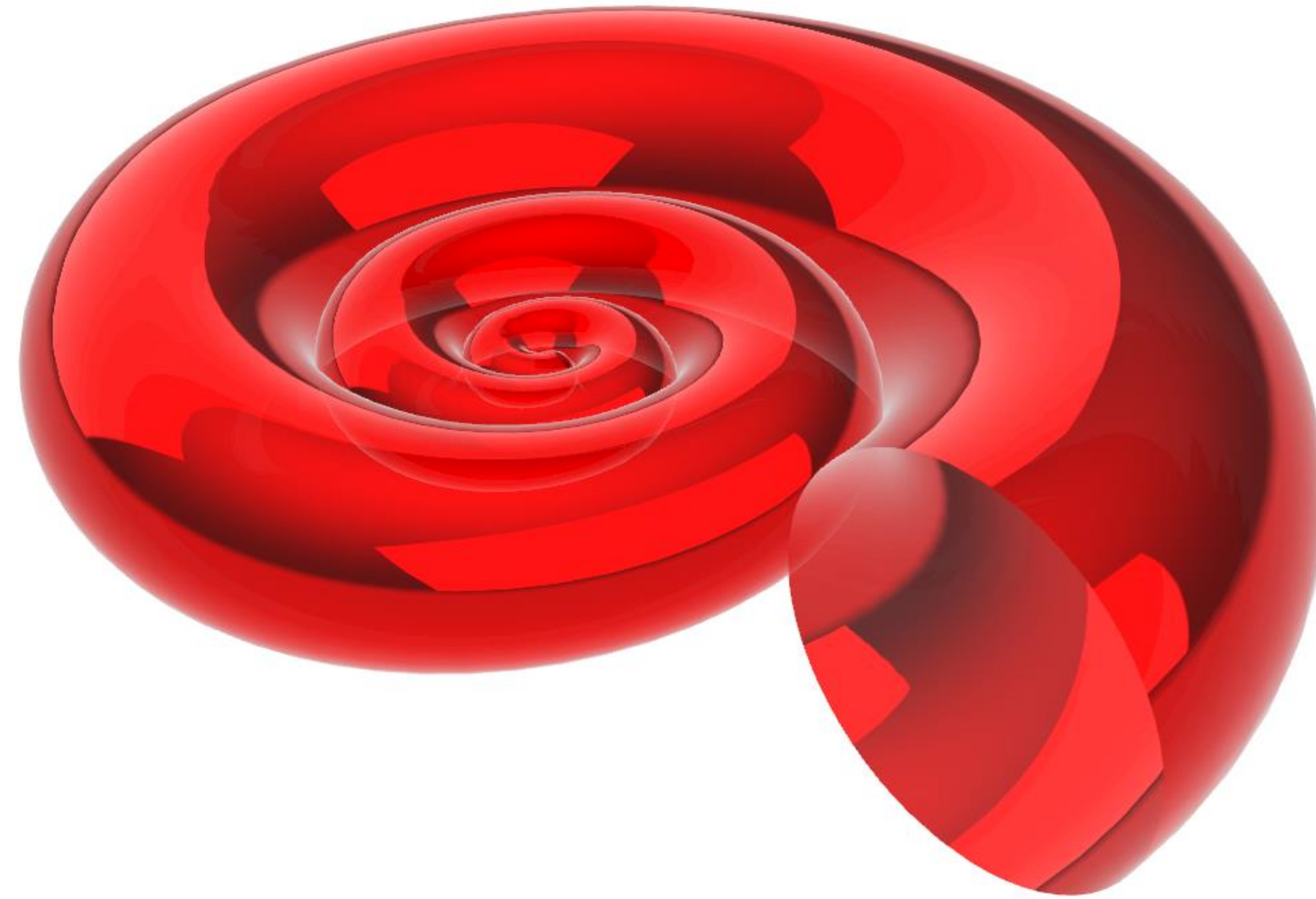

Exerc. 3.2 - Planorbis



Exerc. 3.3 -Nautilus

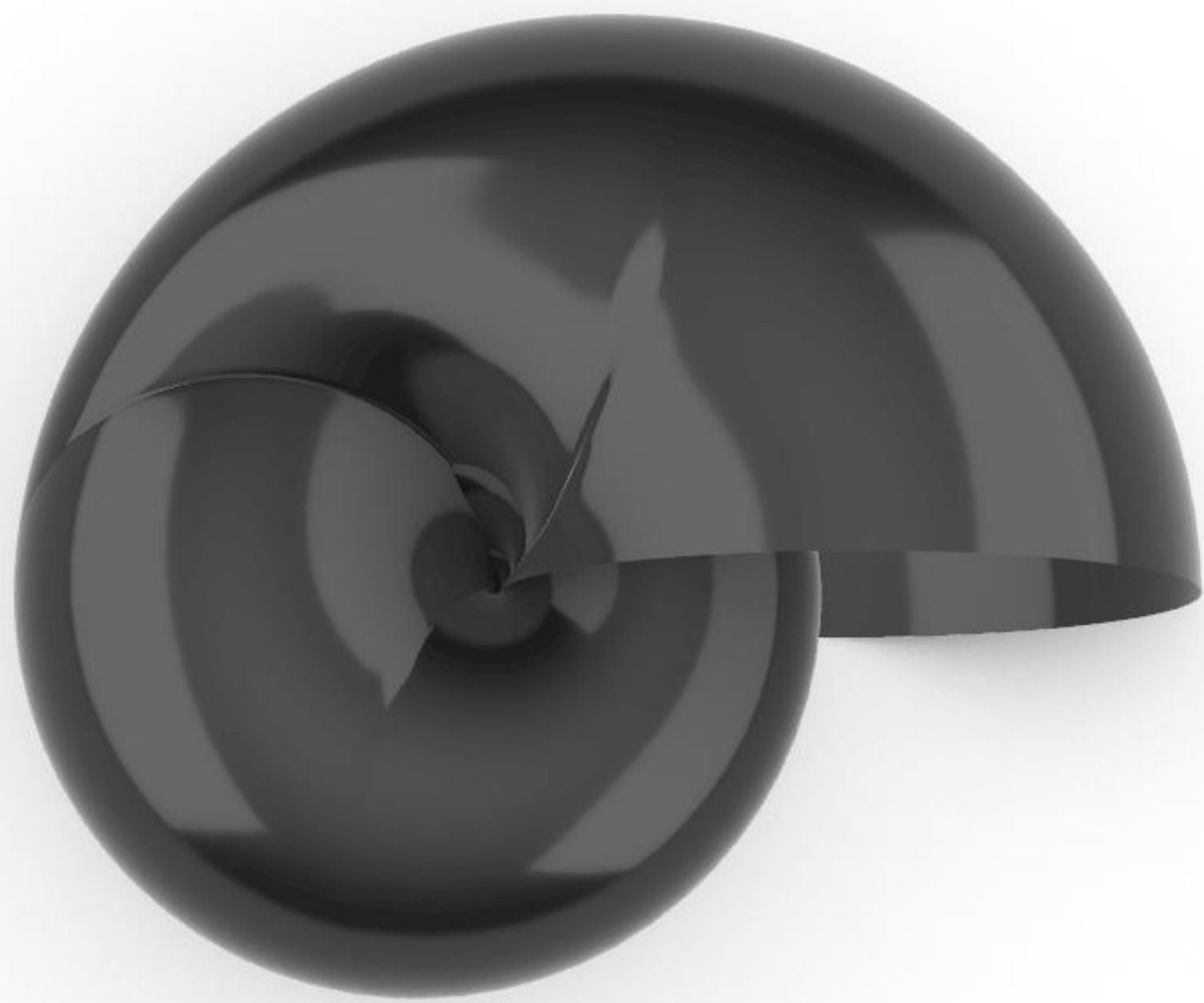

Nautios

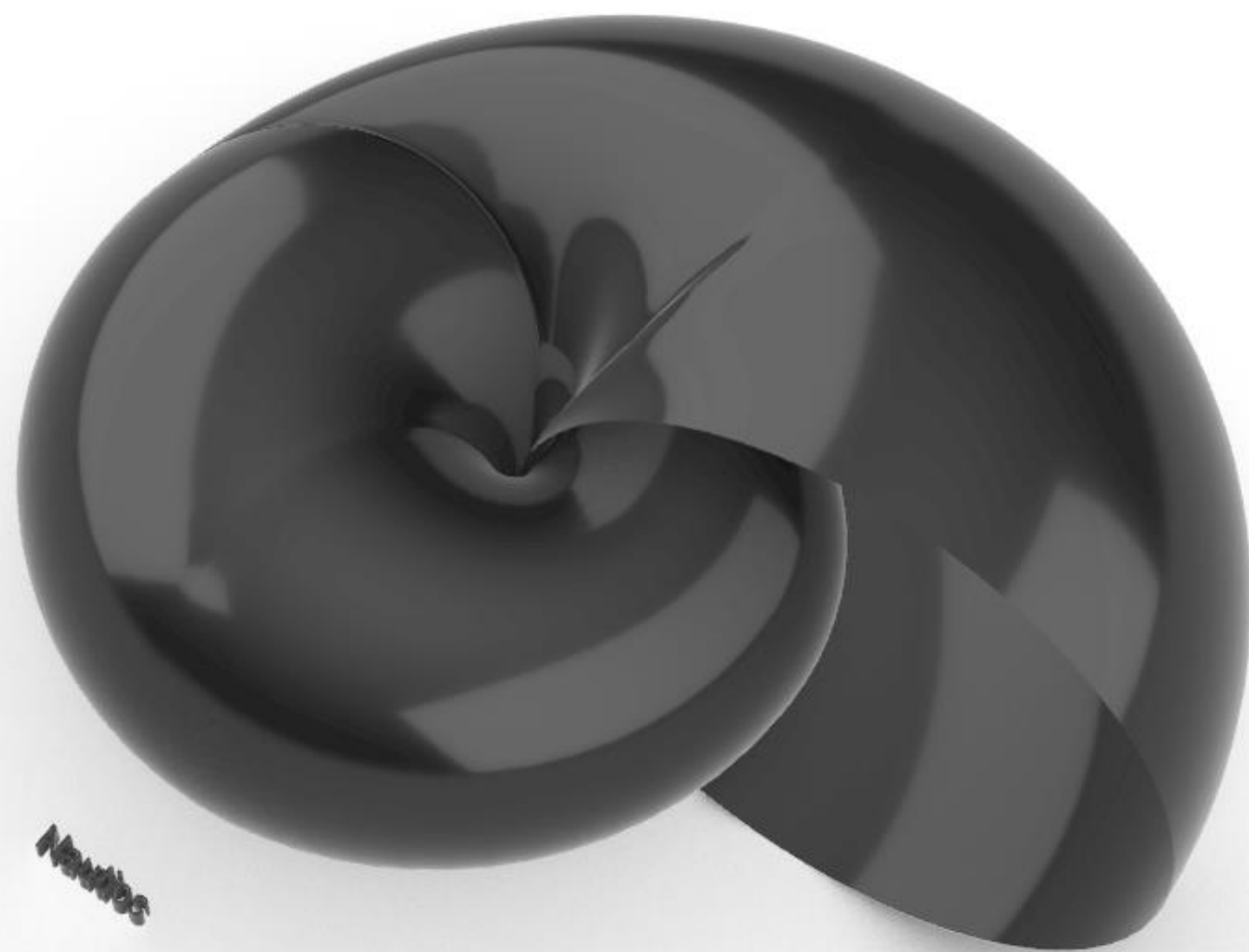

Nautios

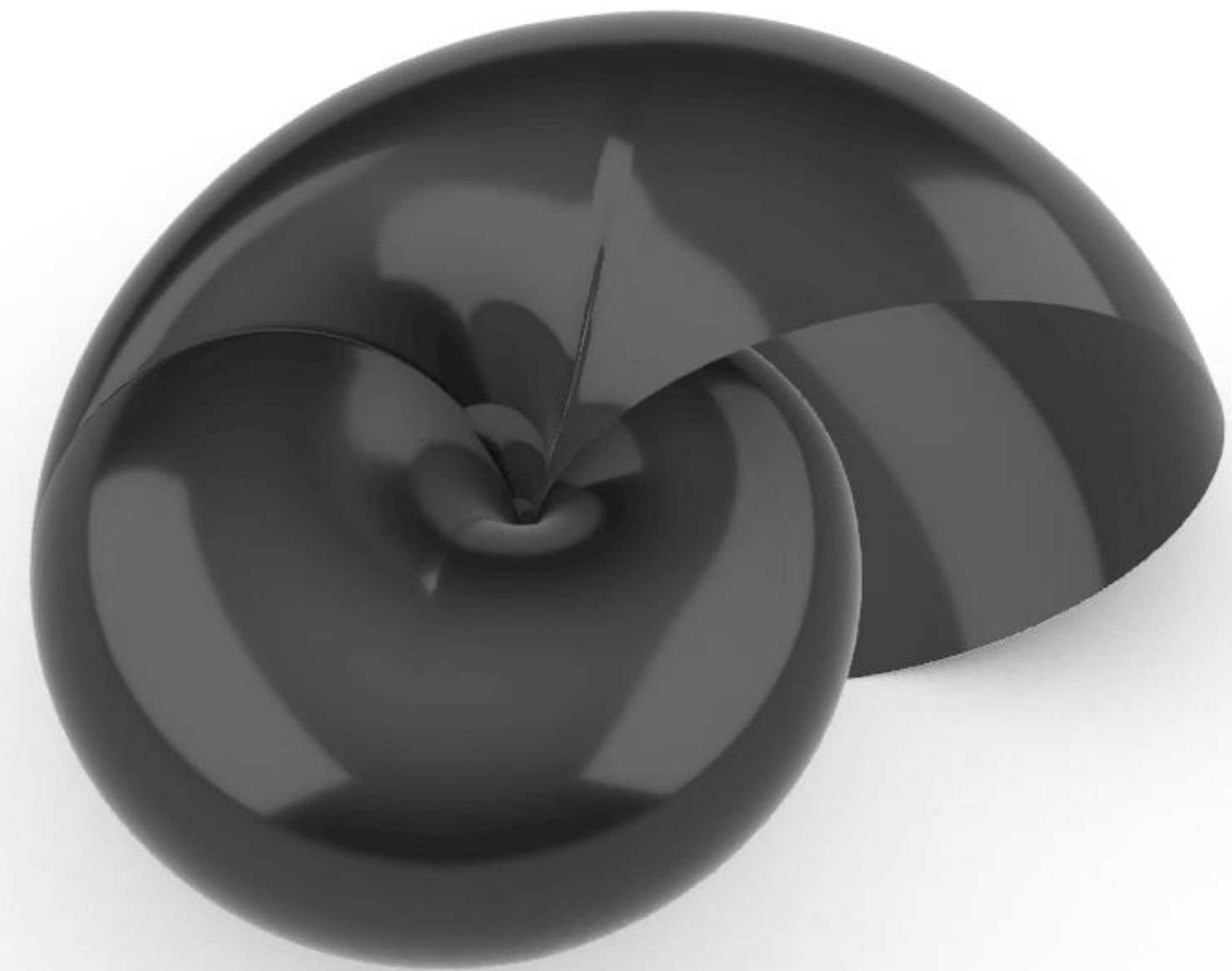

Nautios

Exerc. 3.3 -Nautios



Exerc. 3.3 -Nautius

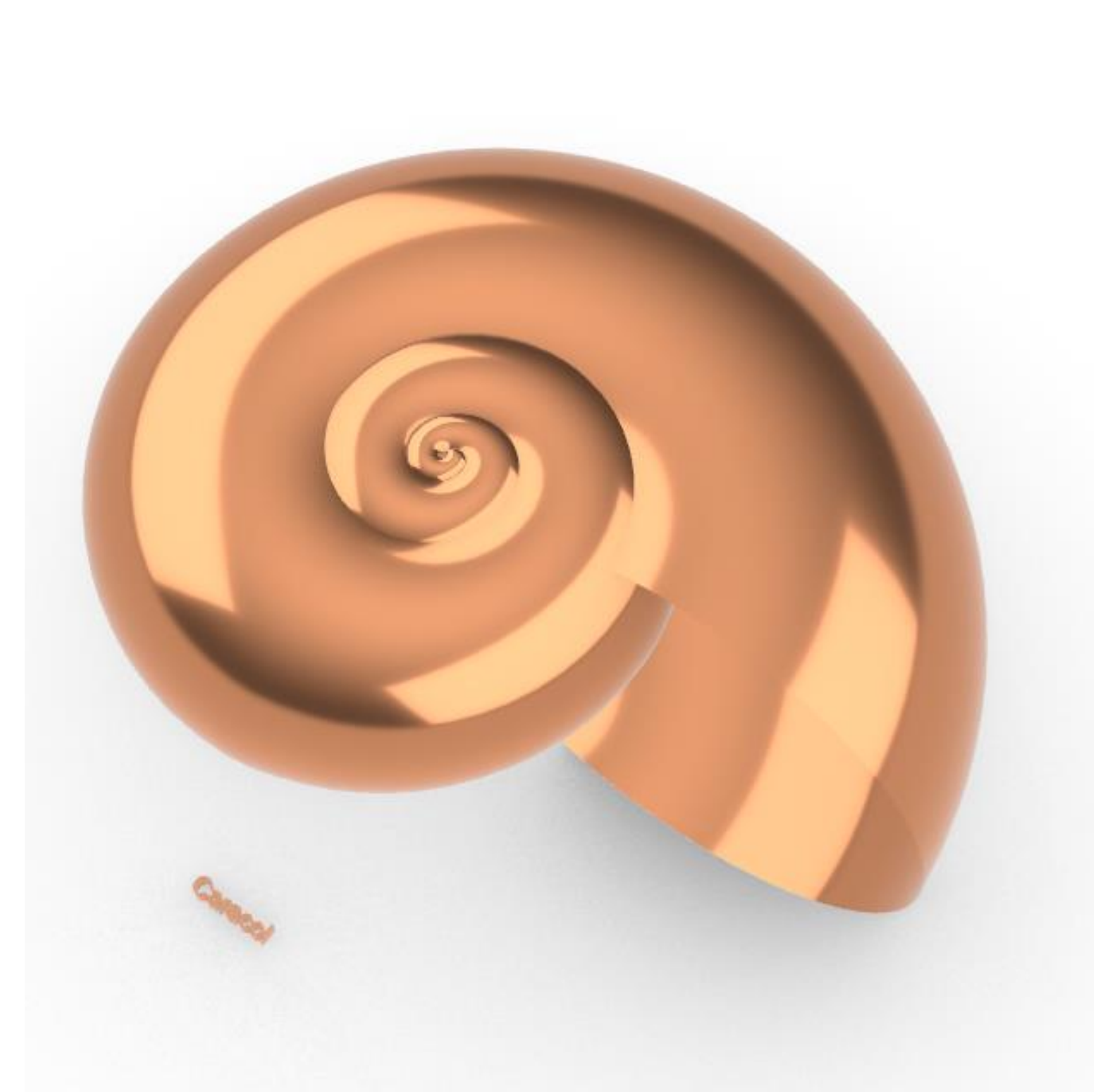
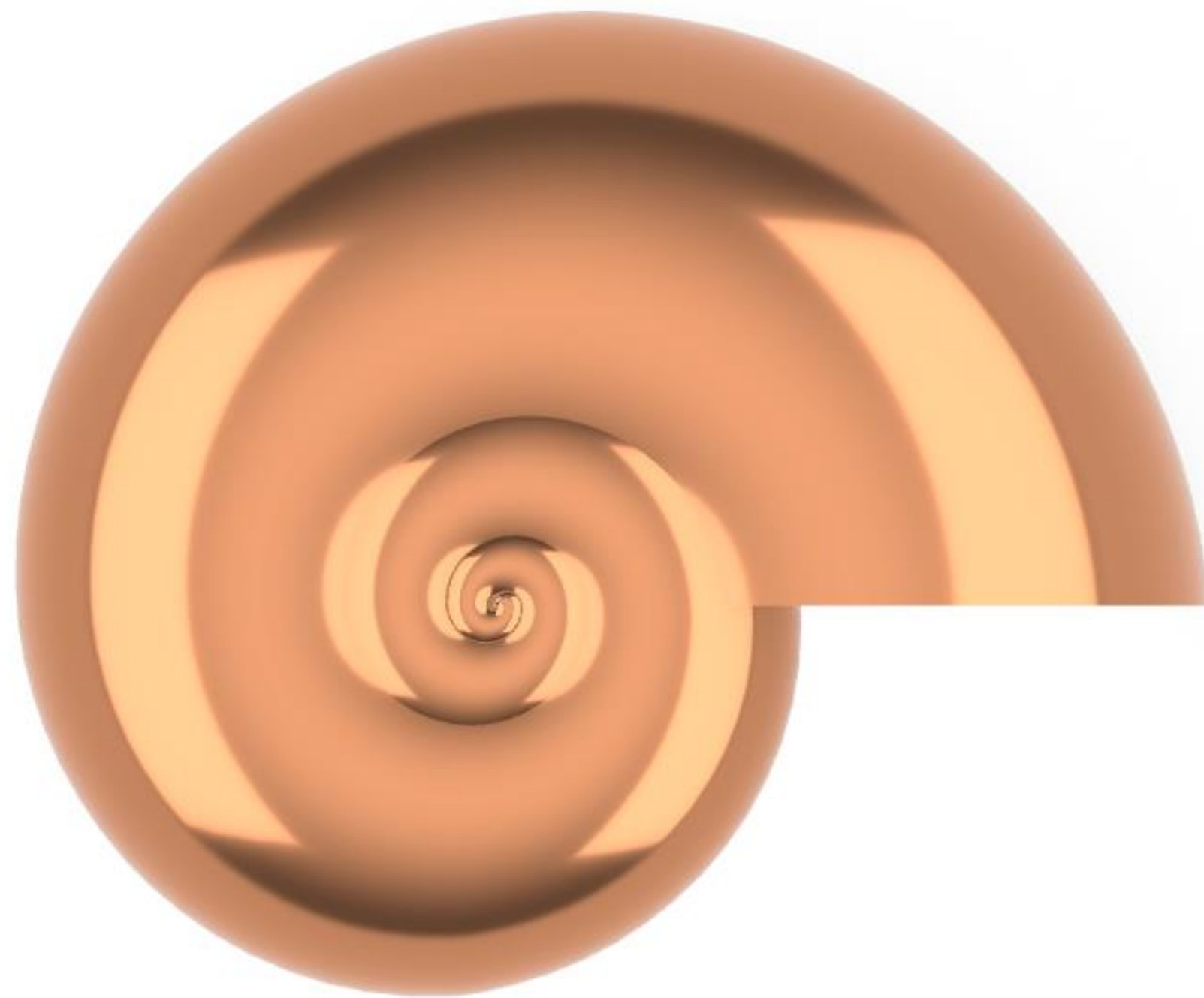
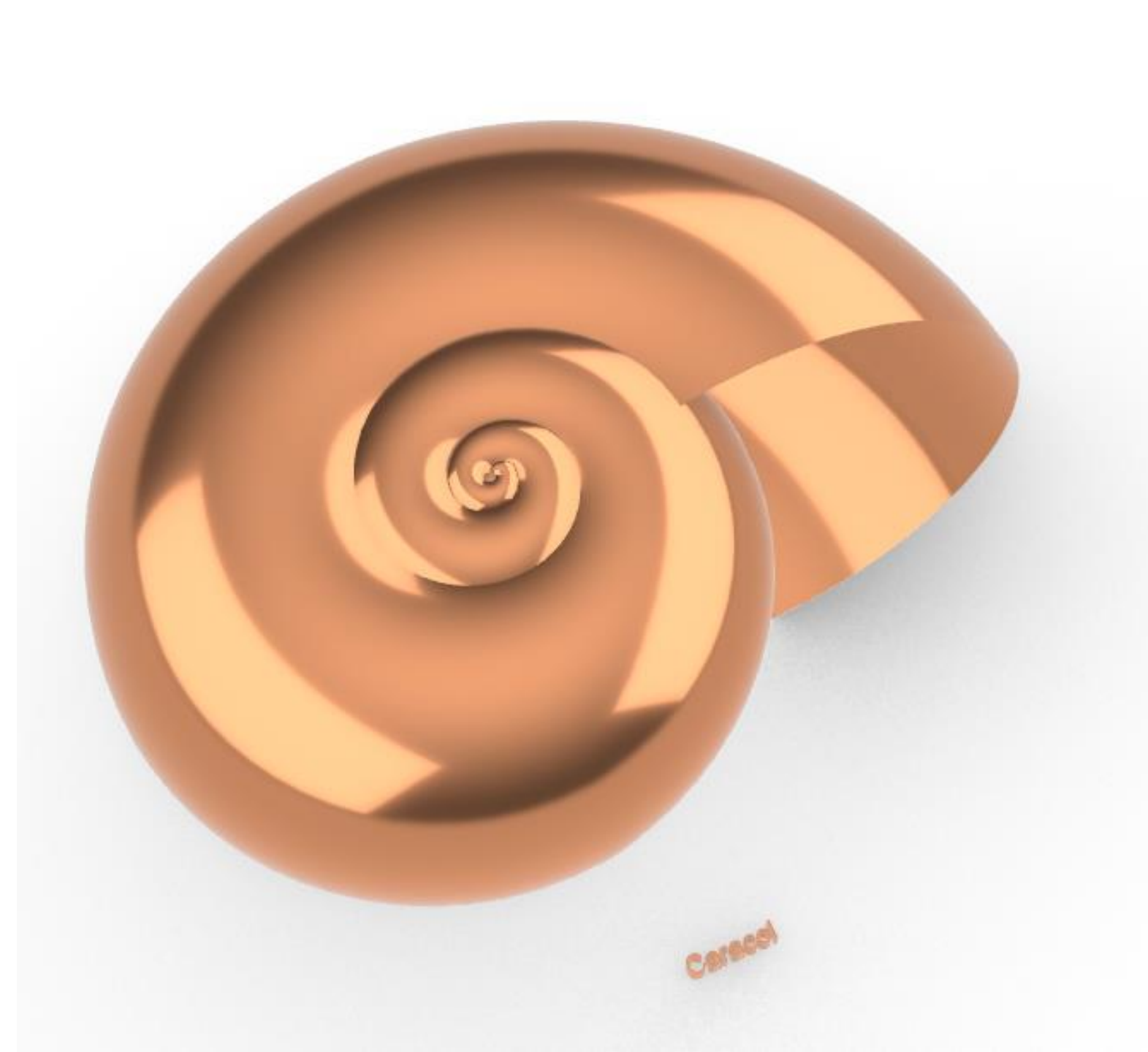

Caracol

Exerc. 3.4 -Caracol



Exerc. 3.4— Caramujo

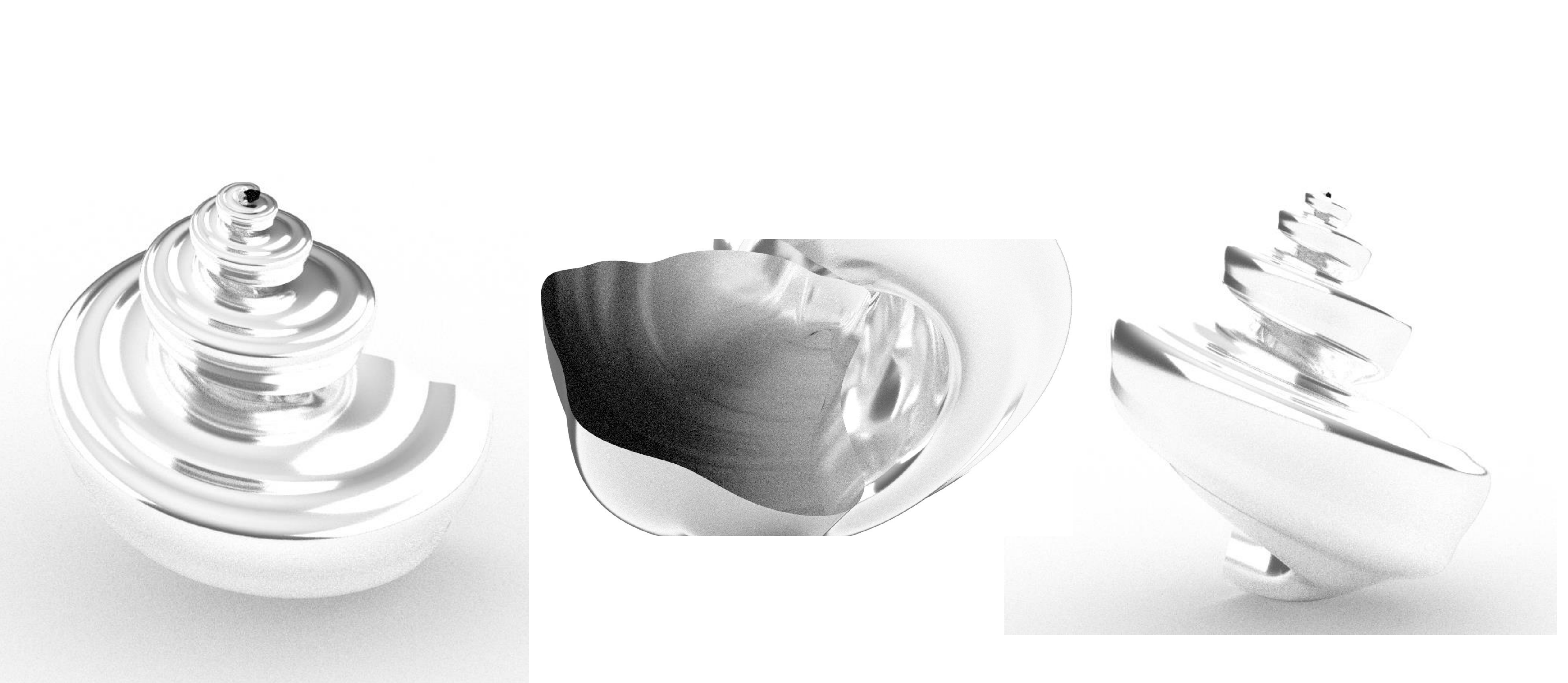

Exerc. 3.5 Elipse Invertida em Caramujo

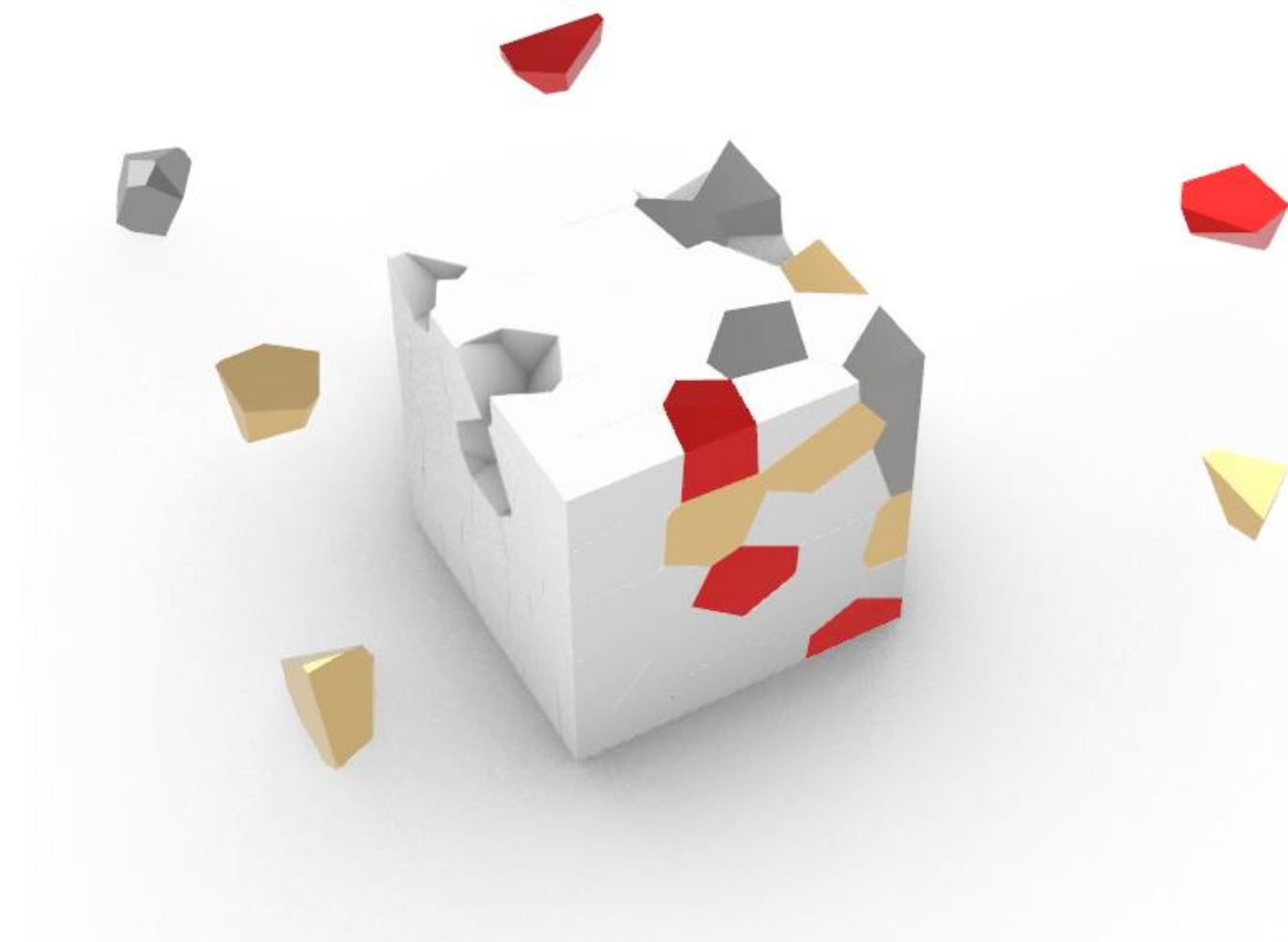
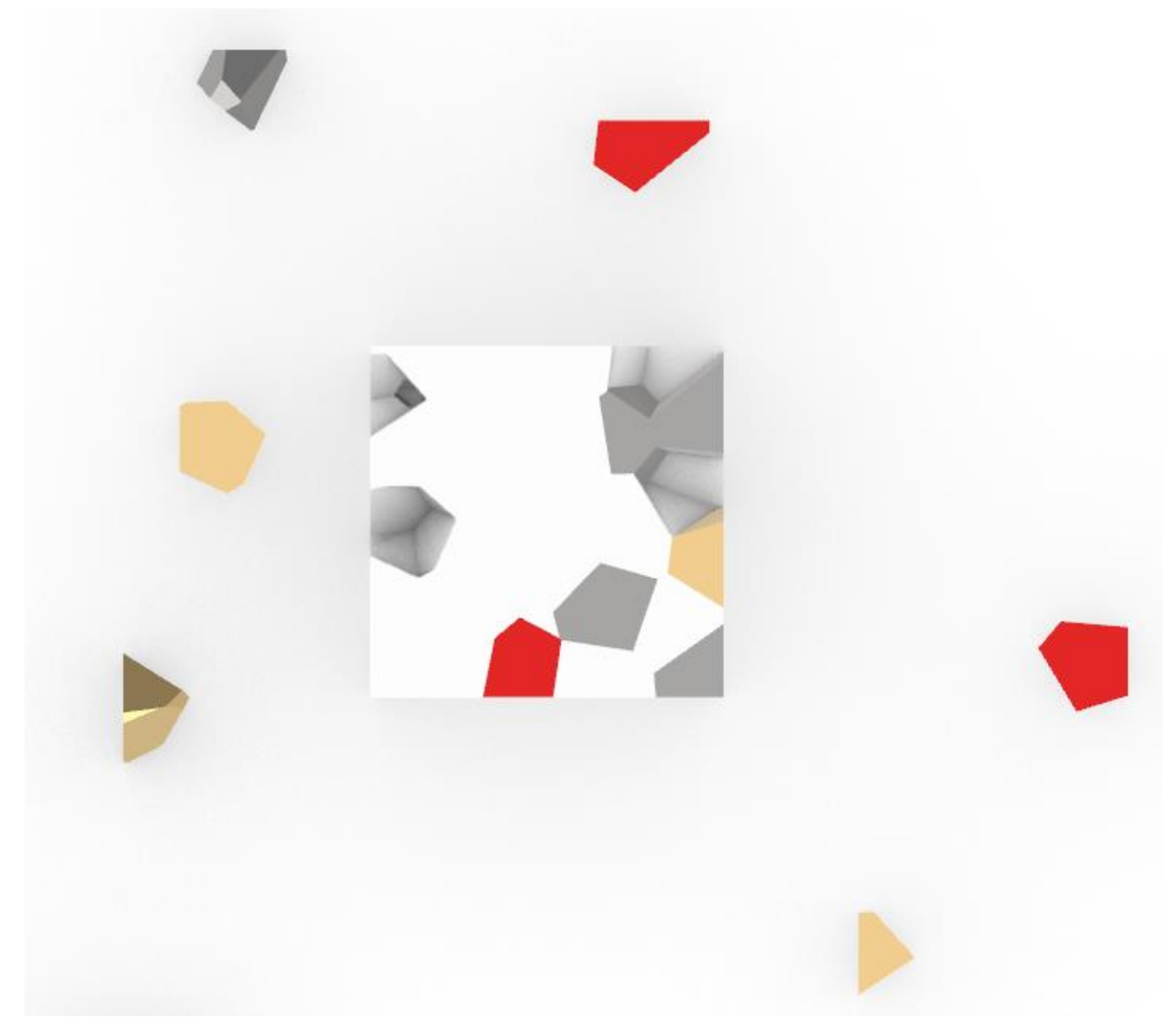
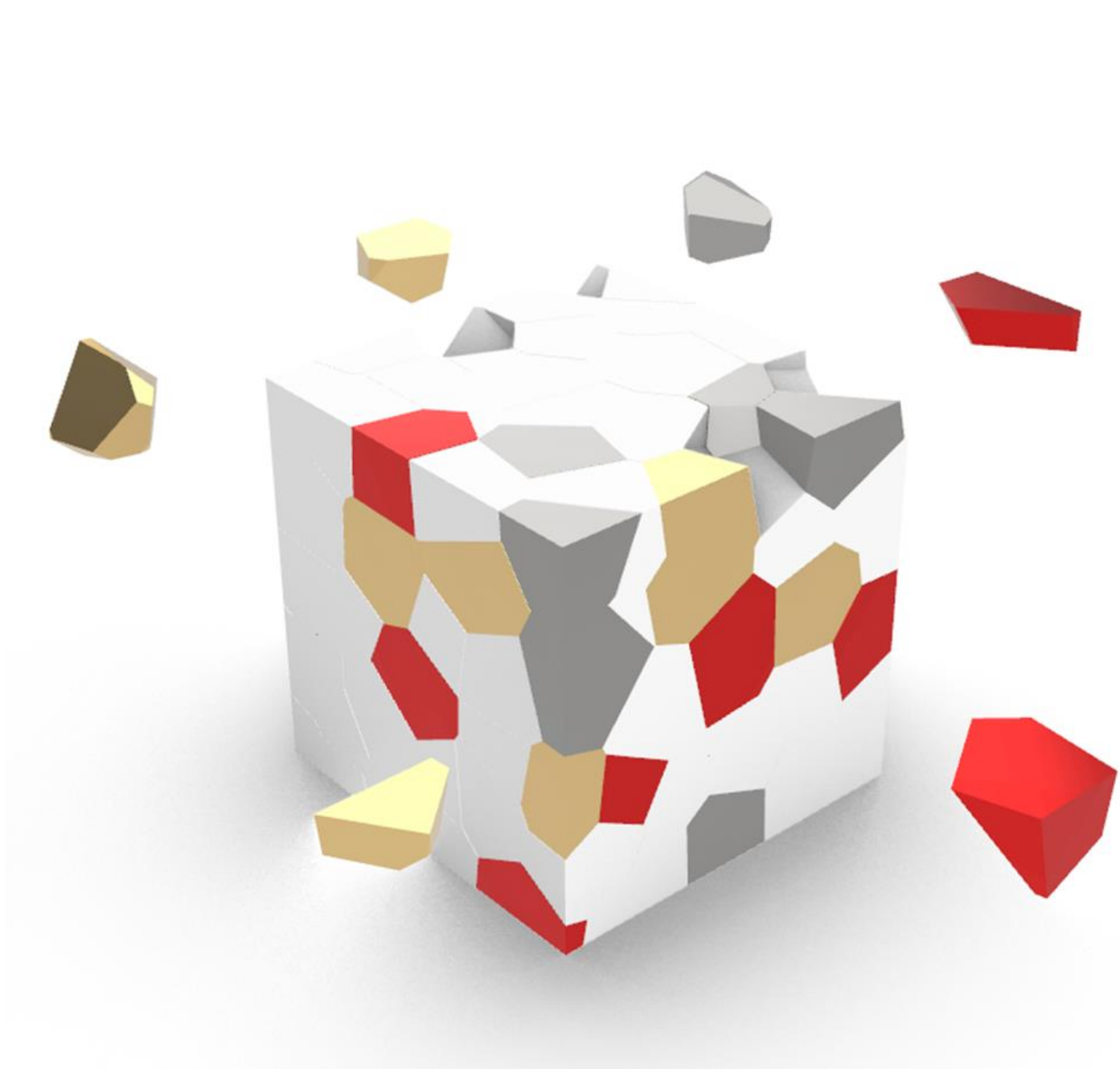

Exerc. 4.0 Cubo Fragmentado

Exerc. 5.0- Terrenos

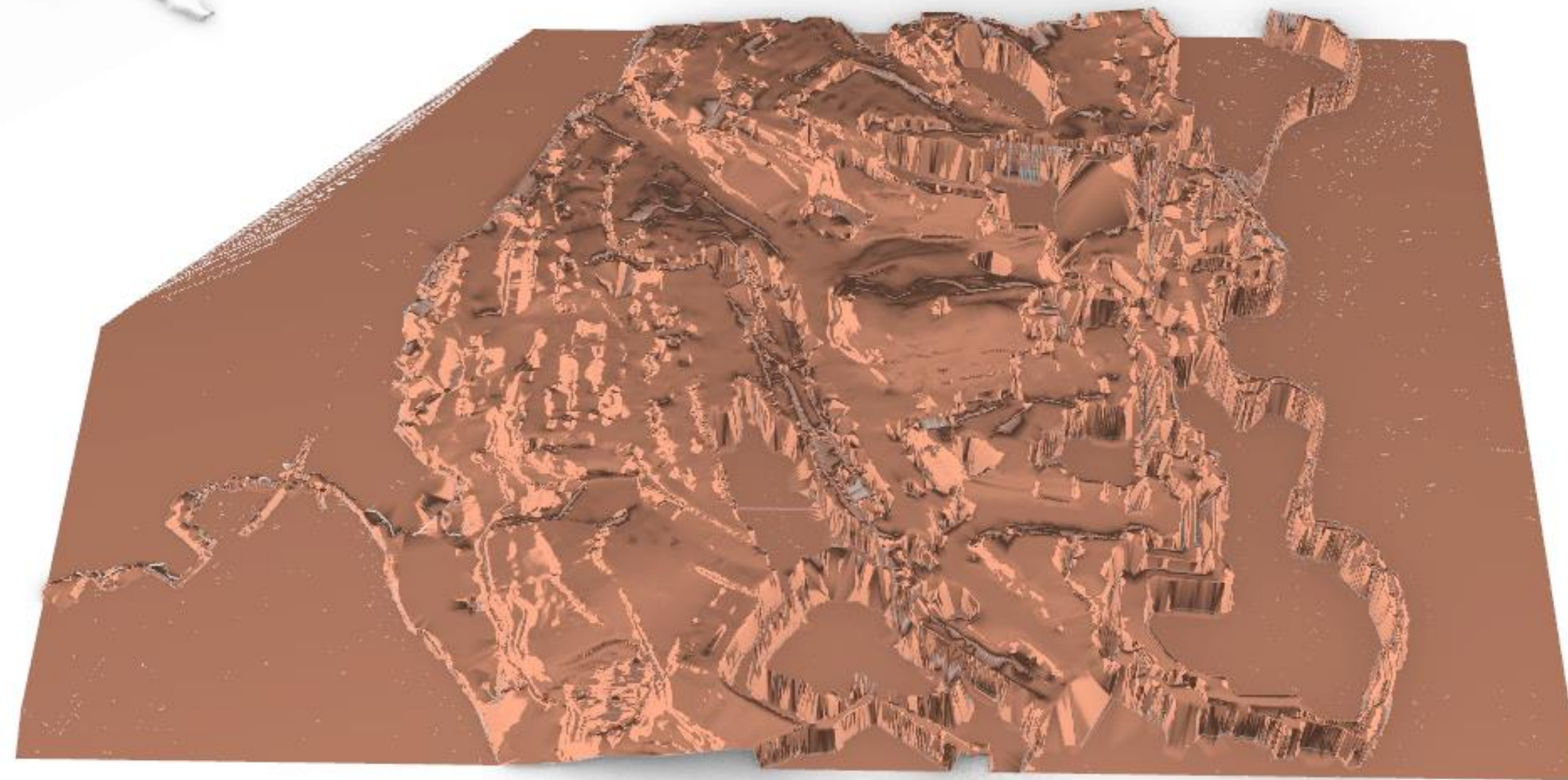
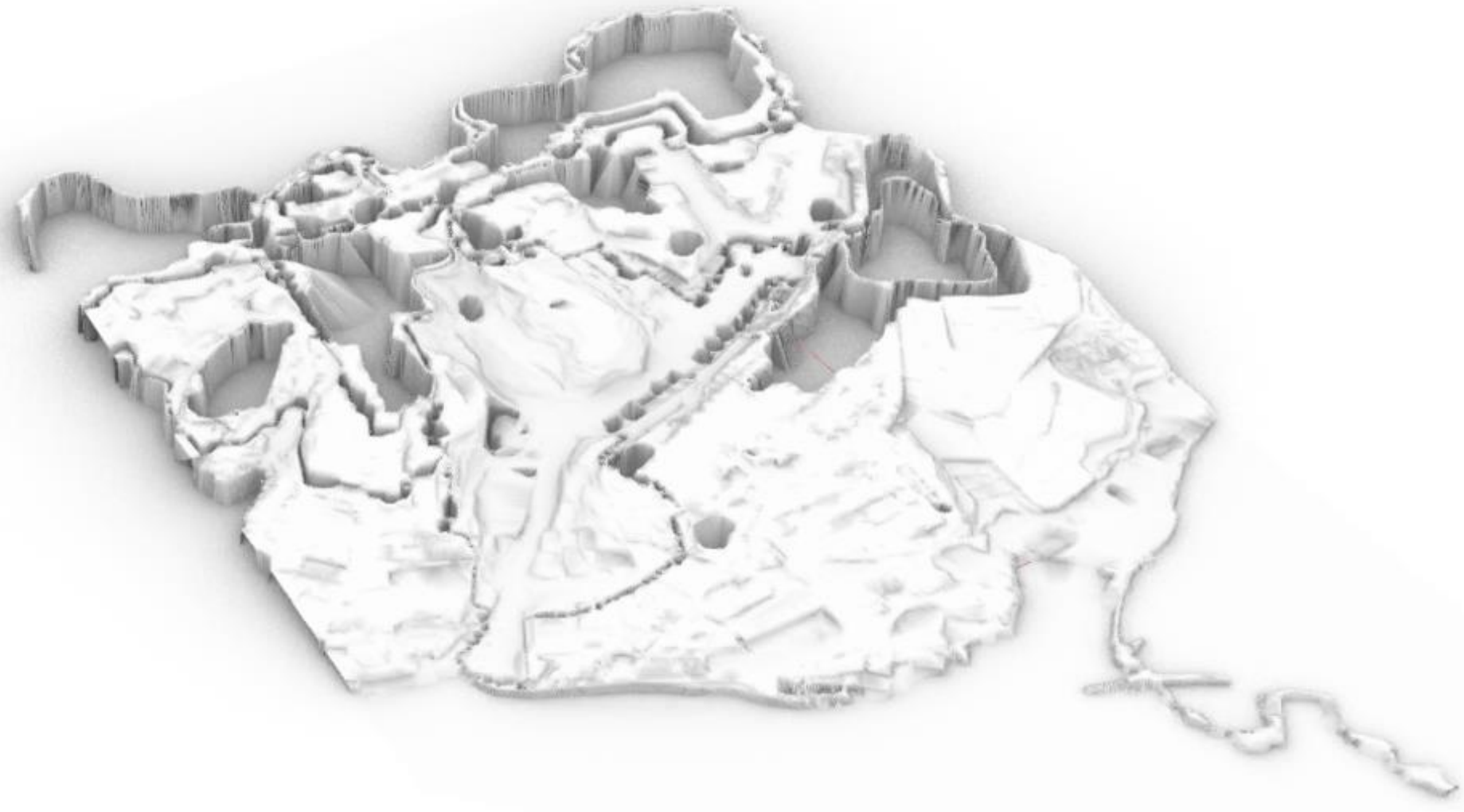

Exerc. 5.1 - Terreno de Hipotetico

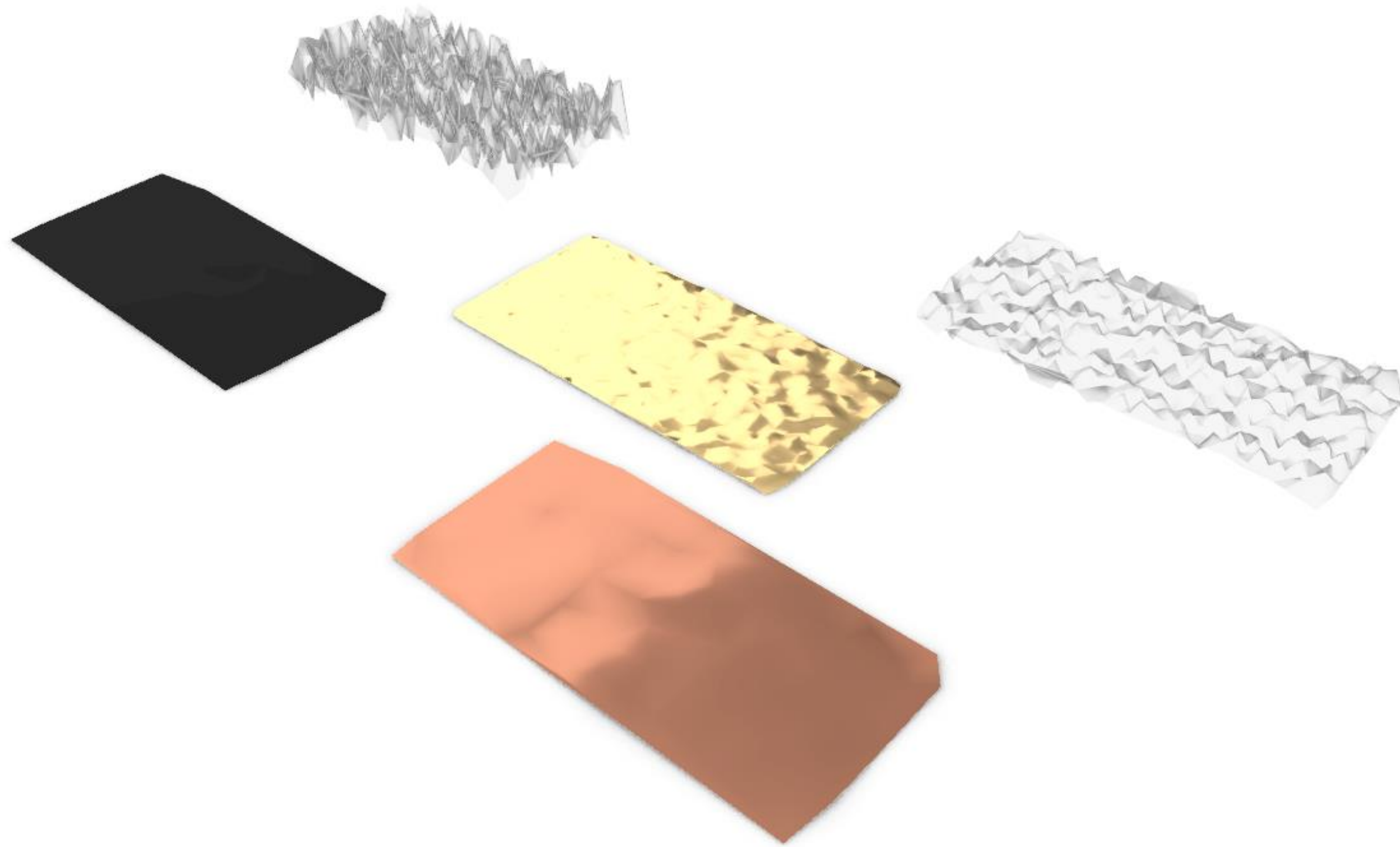

Exerc. 5.2 Terrenos

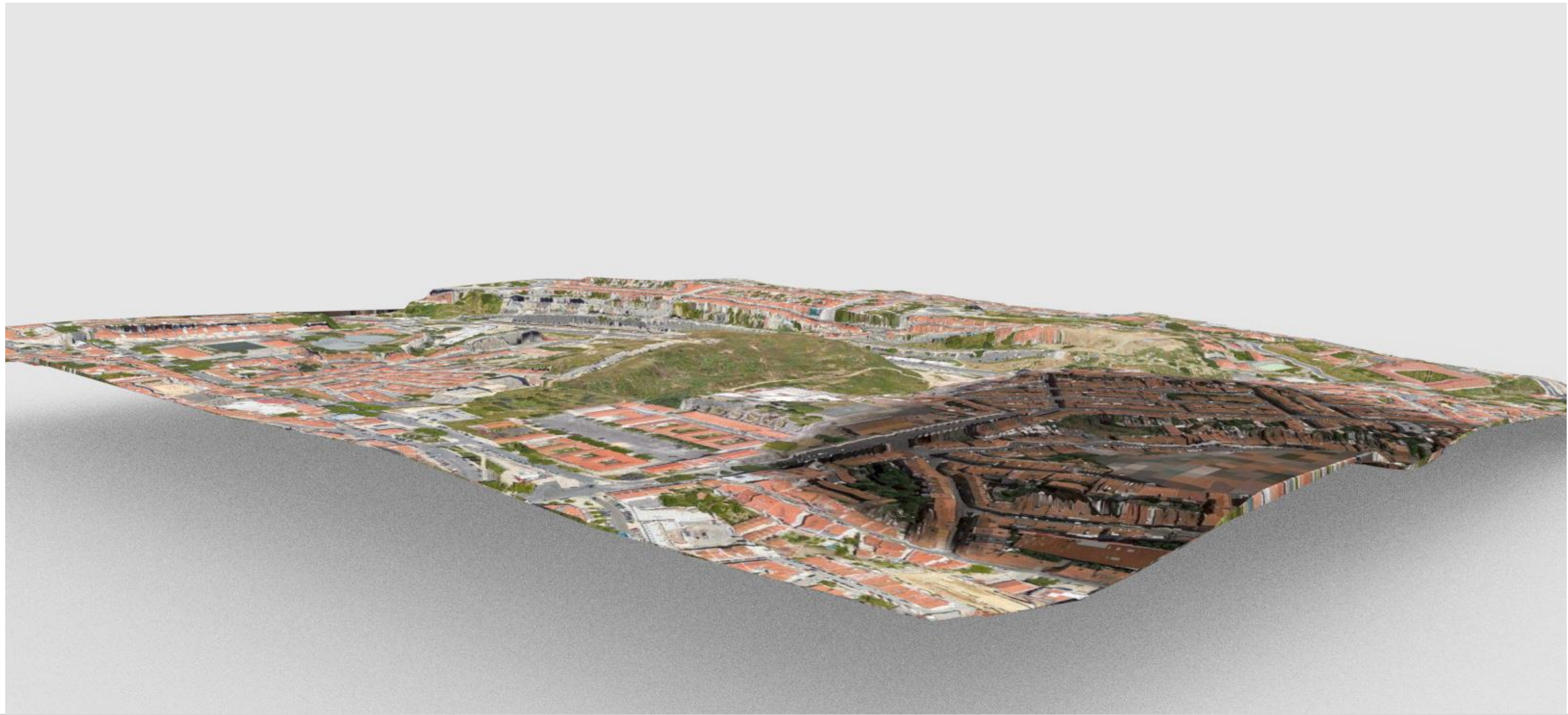
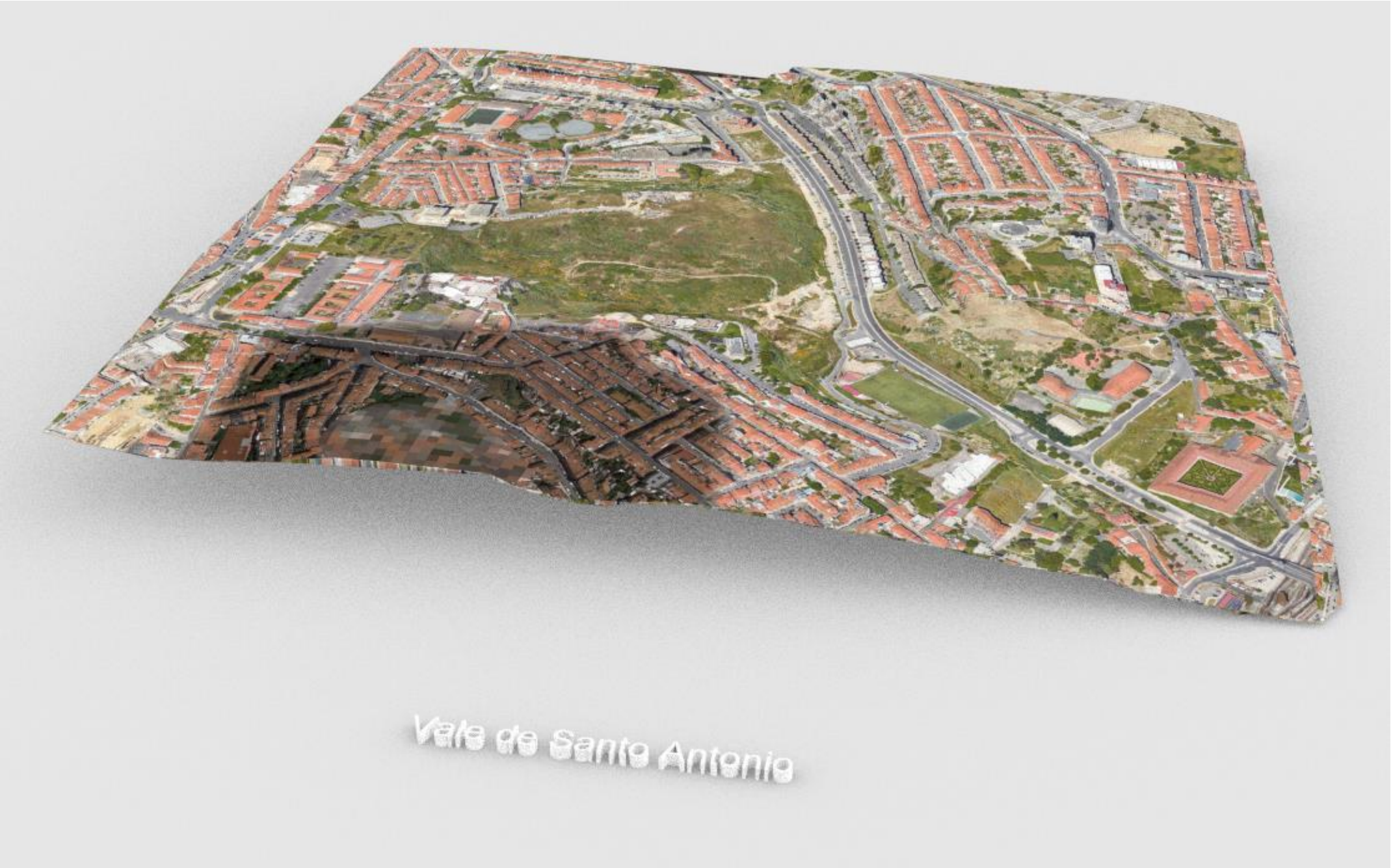

Exerc. 5.3 Terreno de Projeto/ Vale de Santo António



Exerc. 6.1 Mexilhão

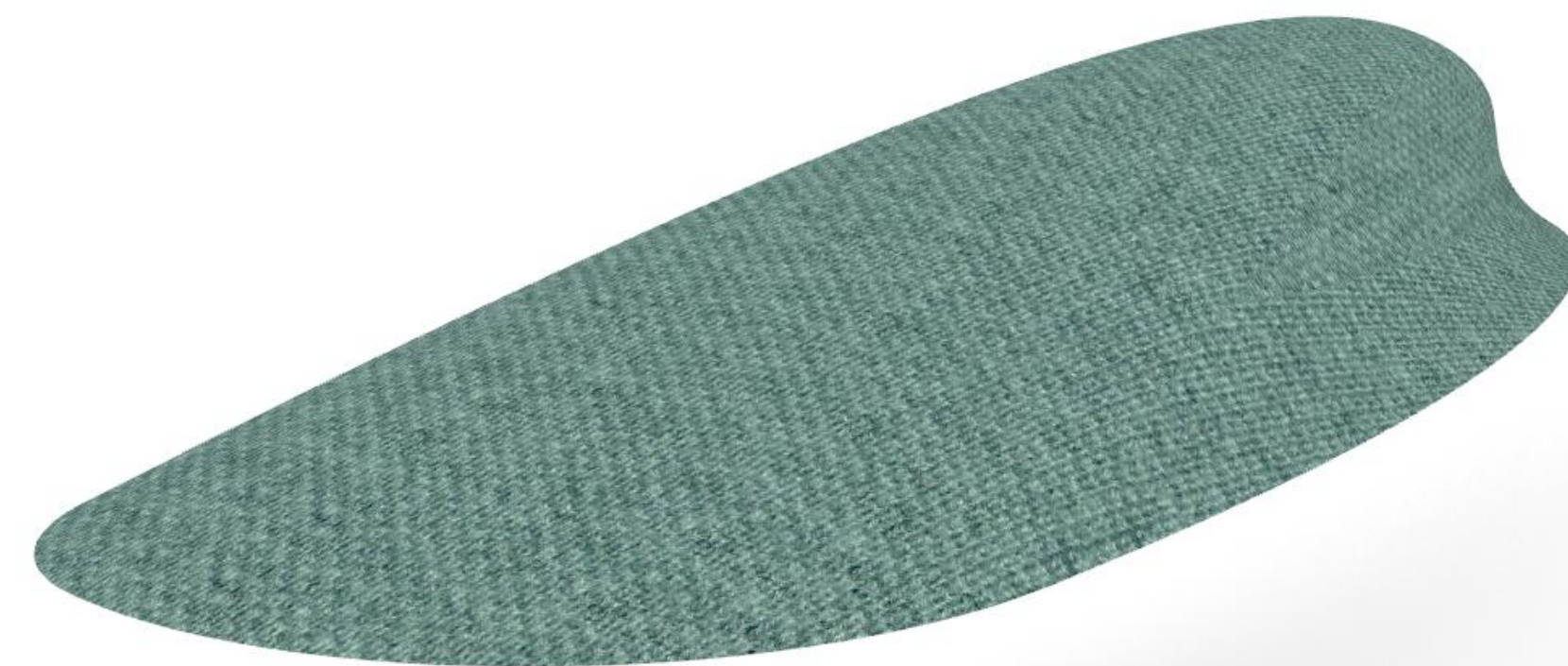

Exerc. 5. Gramujo de Mar
Mexilhão

Exerc. 6.1 Mexilhão



Exerc. 6.2 - Ameijoa

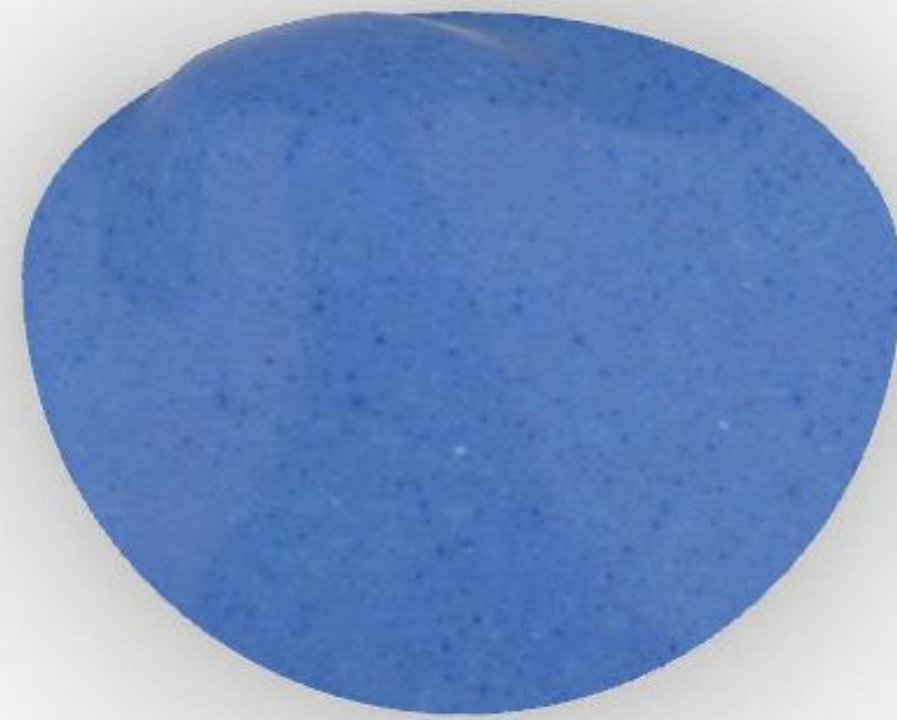

Exe: 5.2 Cramujo do Mar
Ameijoa

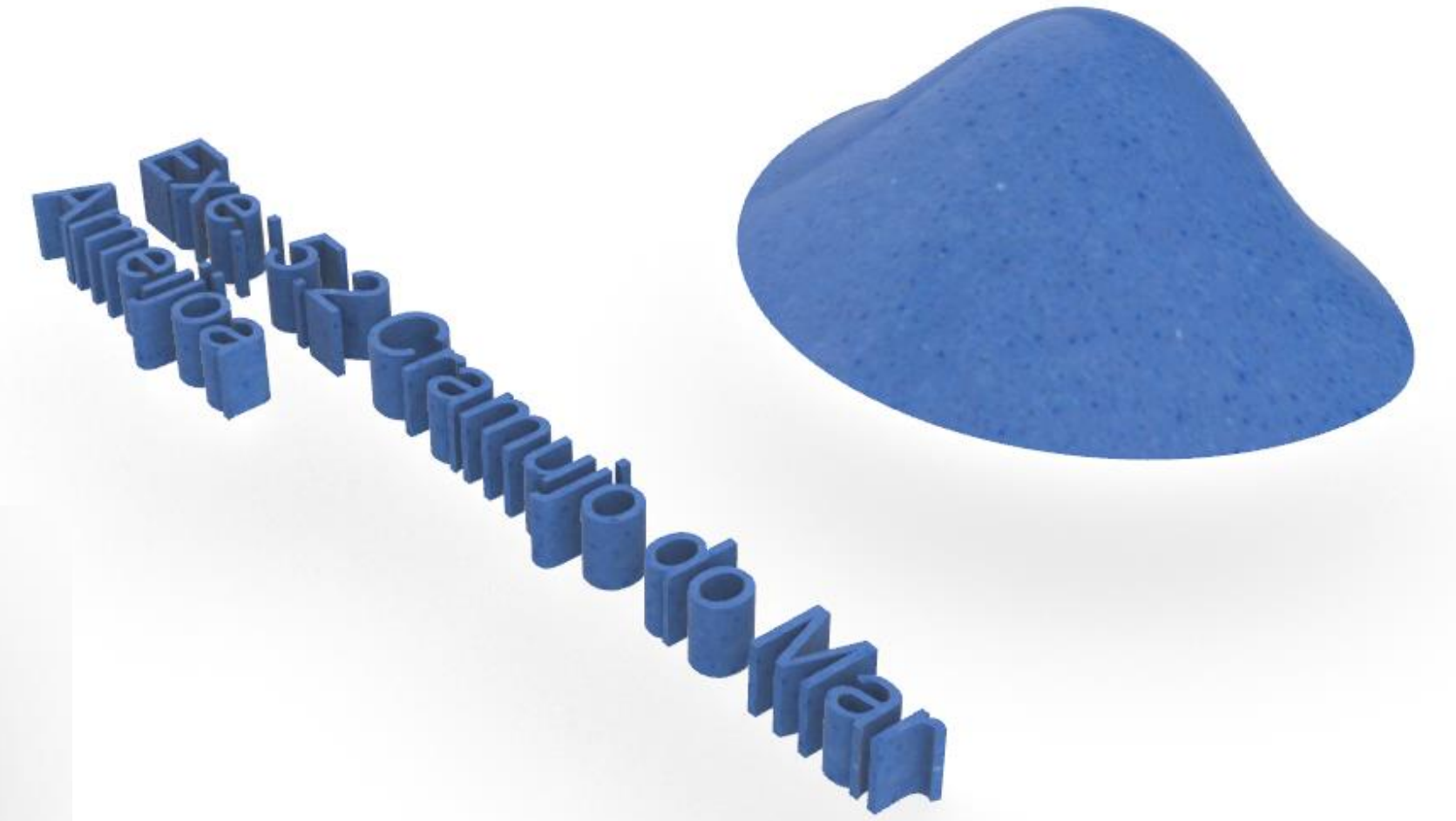

Exerc. 6.2 - Ameijoa



Exerc. 6.3- Vieira

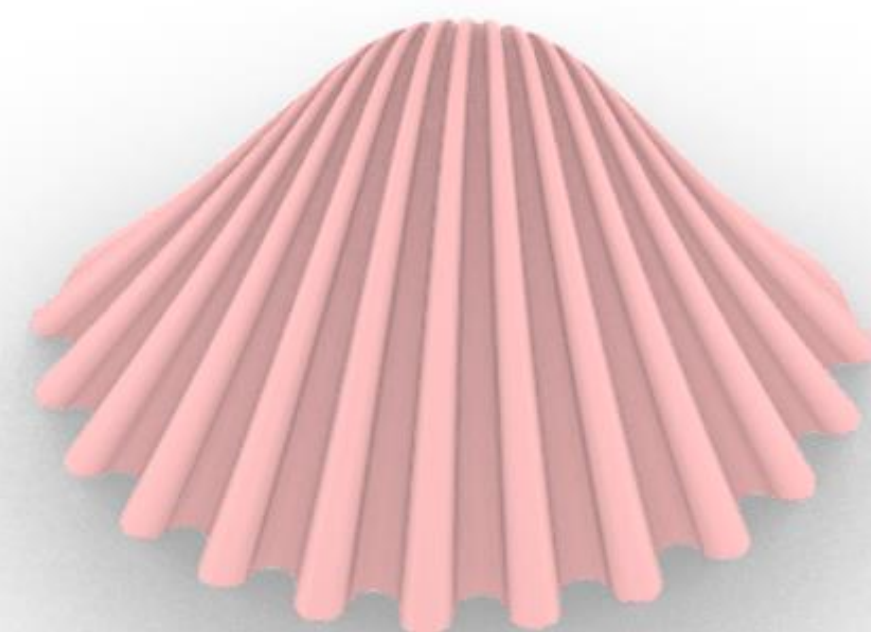
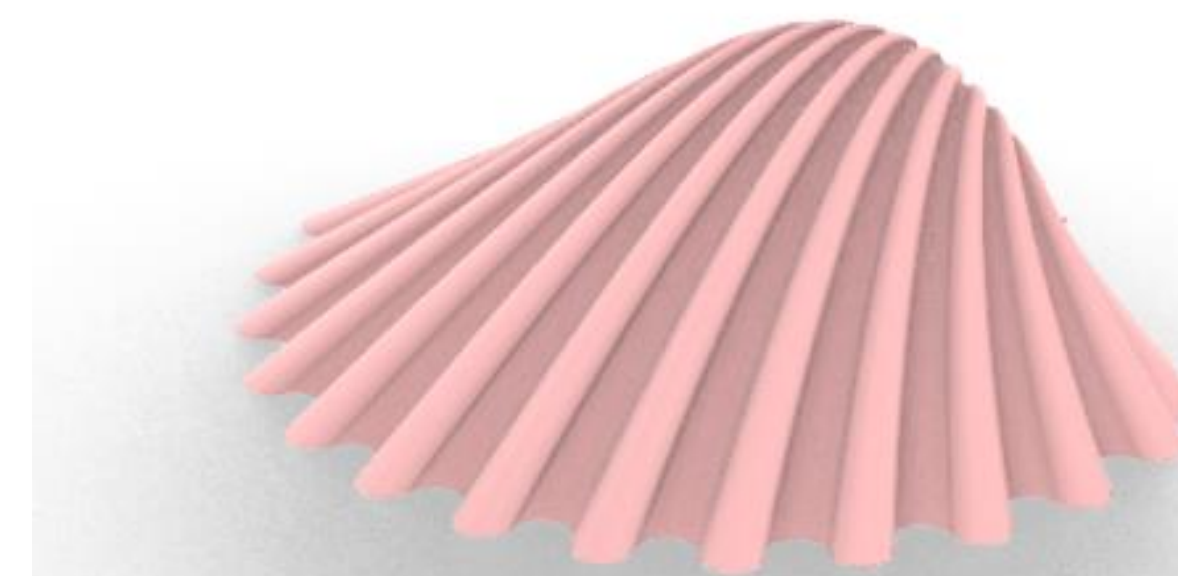
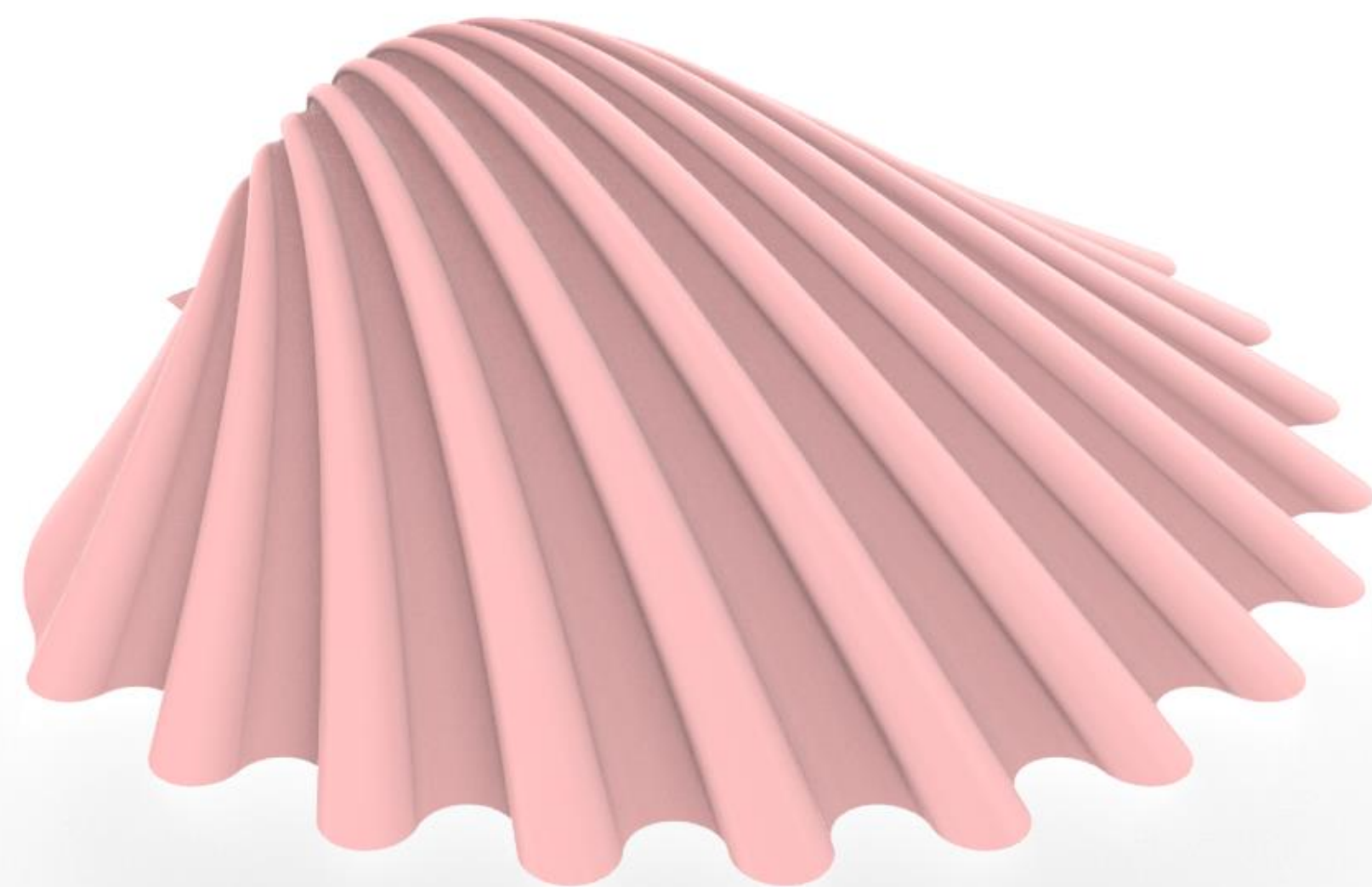

Exer. 5.3 Cramujo do Mar
Vieira

Exerc. 6.3- Vieira



Exerc. 6.4- Ostra/Perola

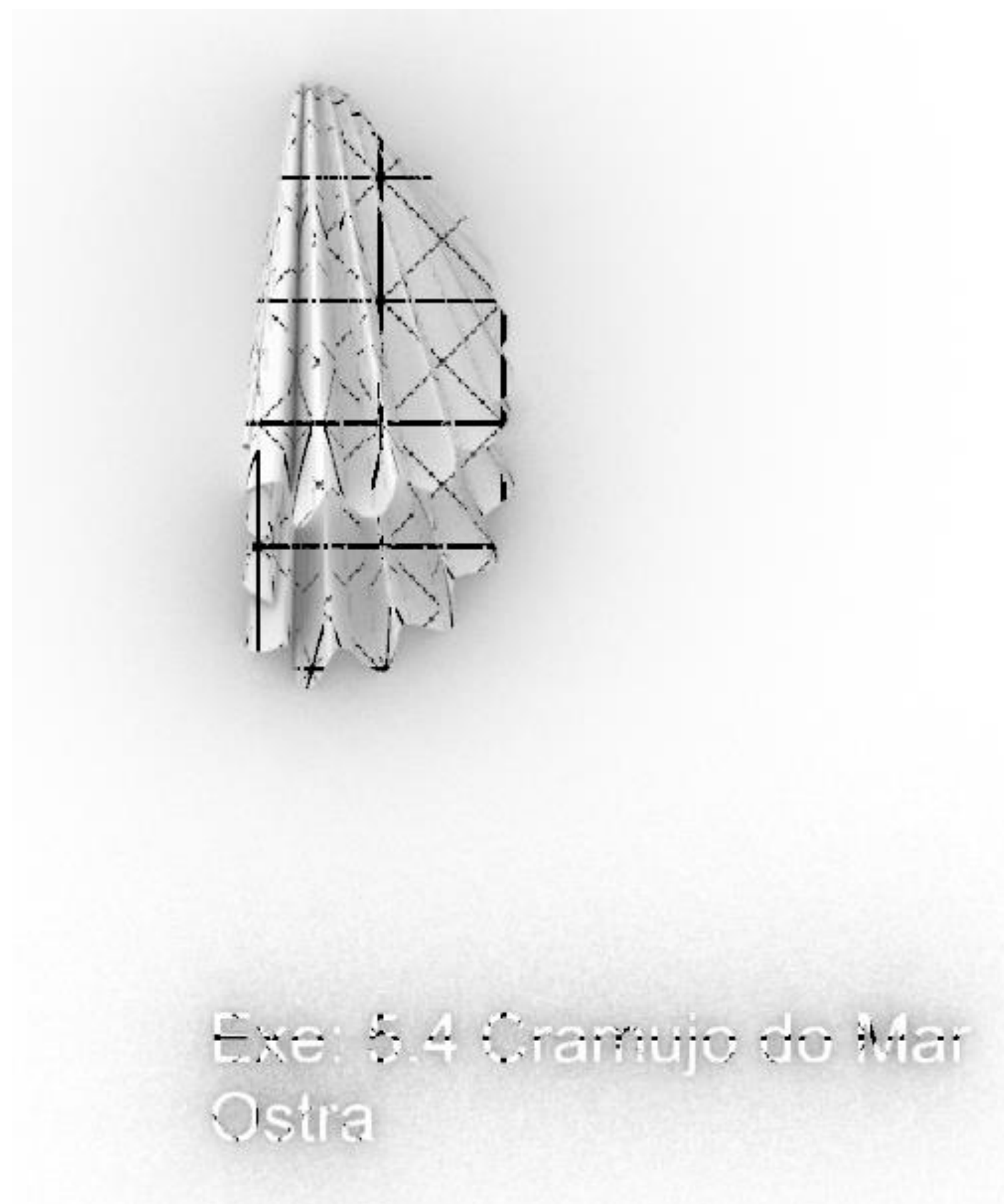
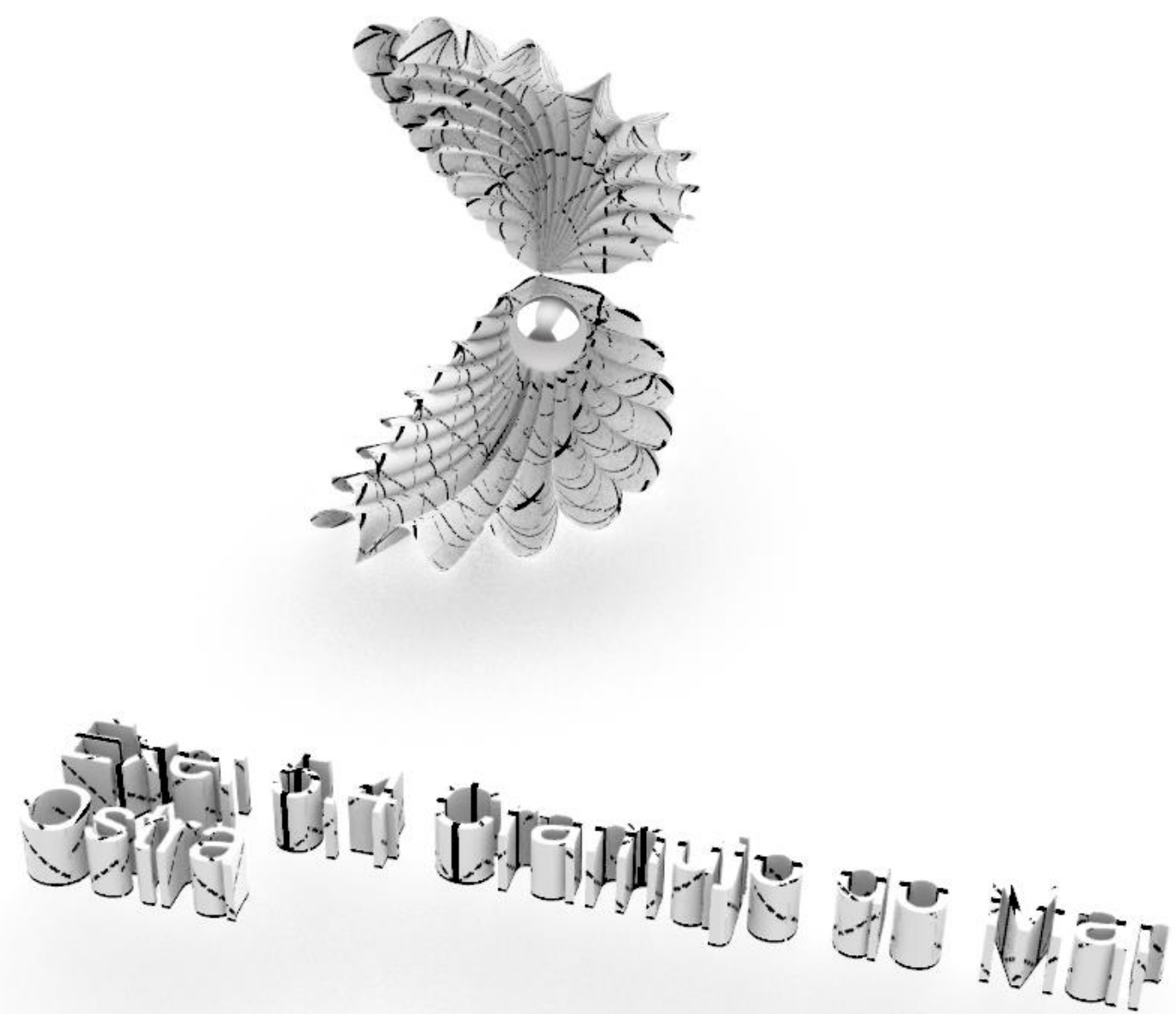

Exerc. 6.4- Ostra/Perola



Exerc.7. Corais



Exerc. 6.1 Coral Espinosa

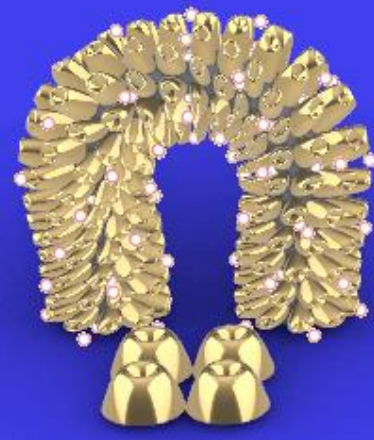

Exerc. 6.2 Coral Botolphsey



Exerc. 6.3 Coral 3



Exerc. 6.4 Coral 4

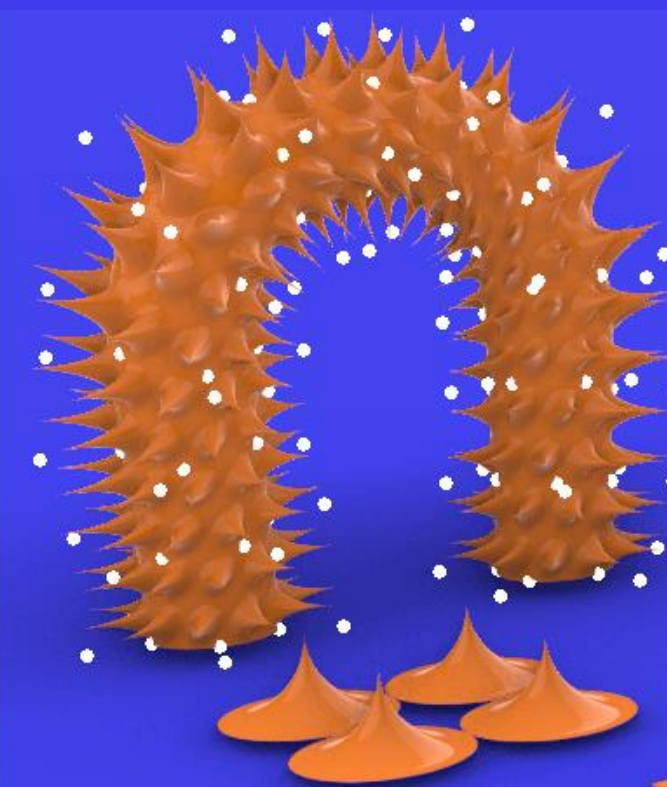

Exerc. 6.1 Coral Espinosa

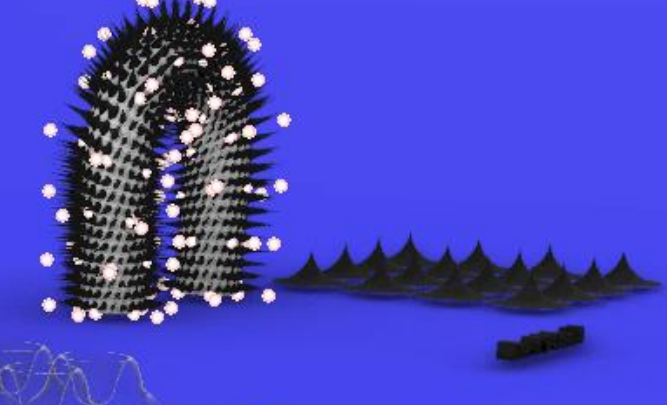
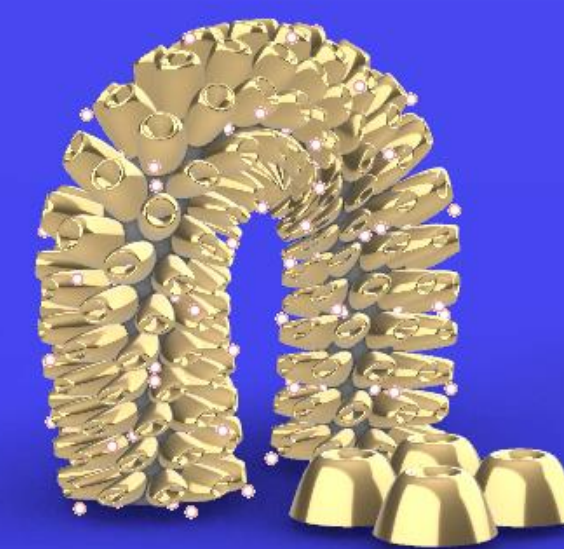

Exerc.7.0 Corais

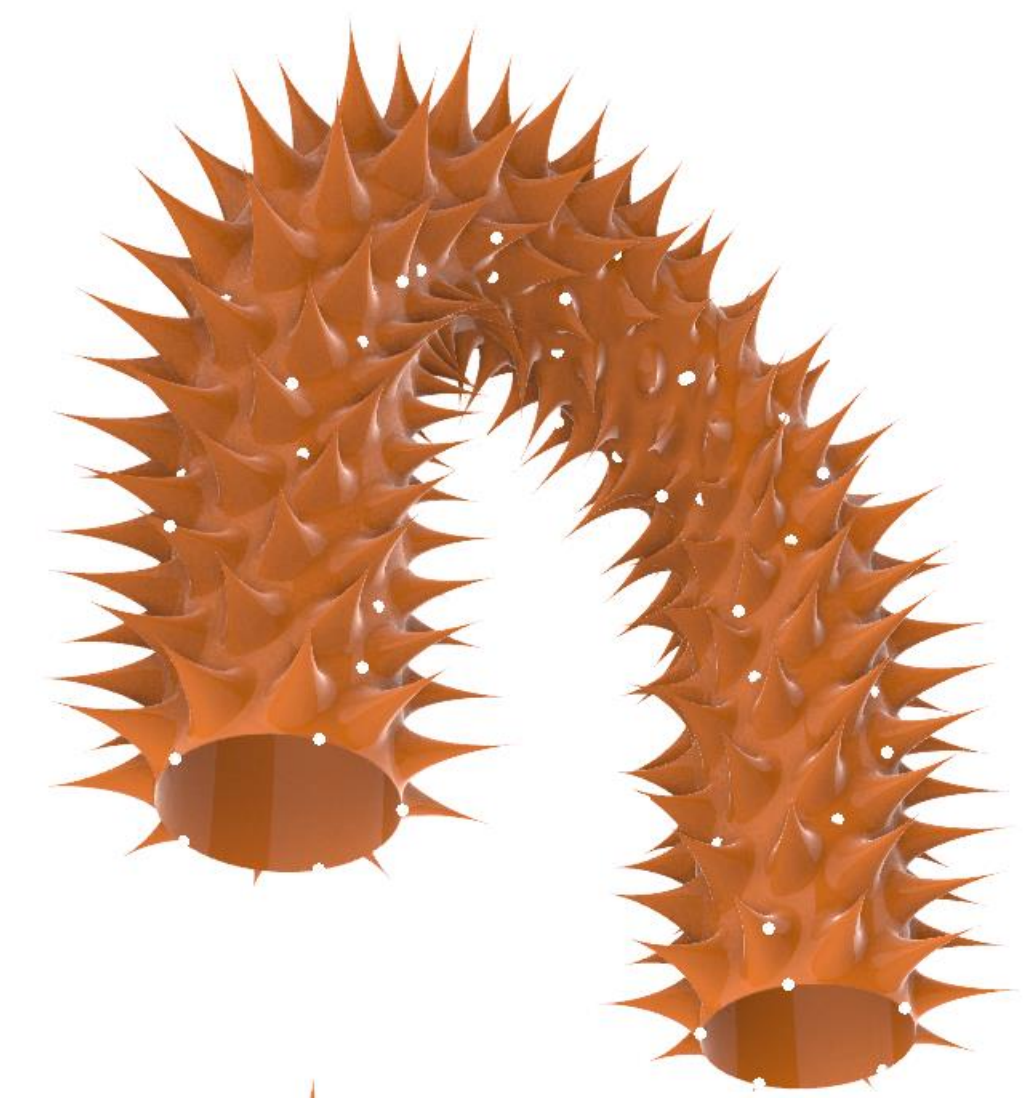
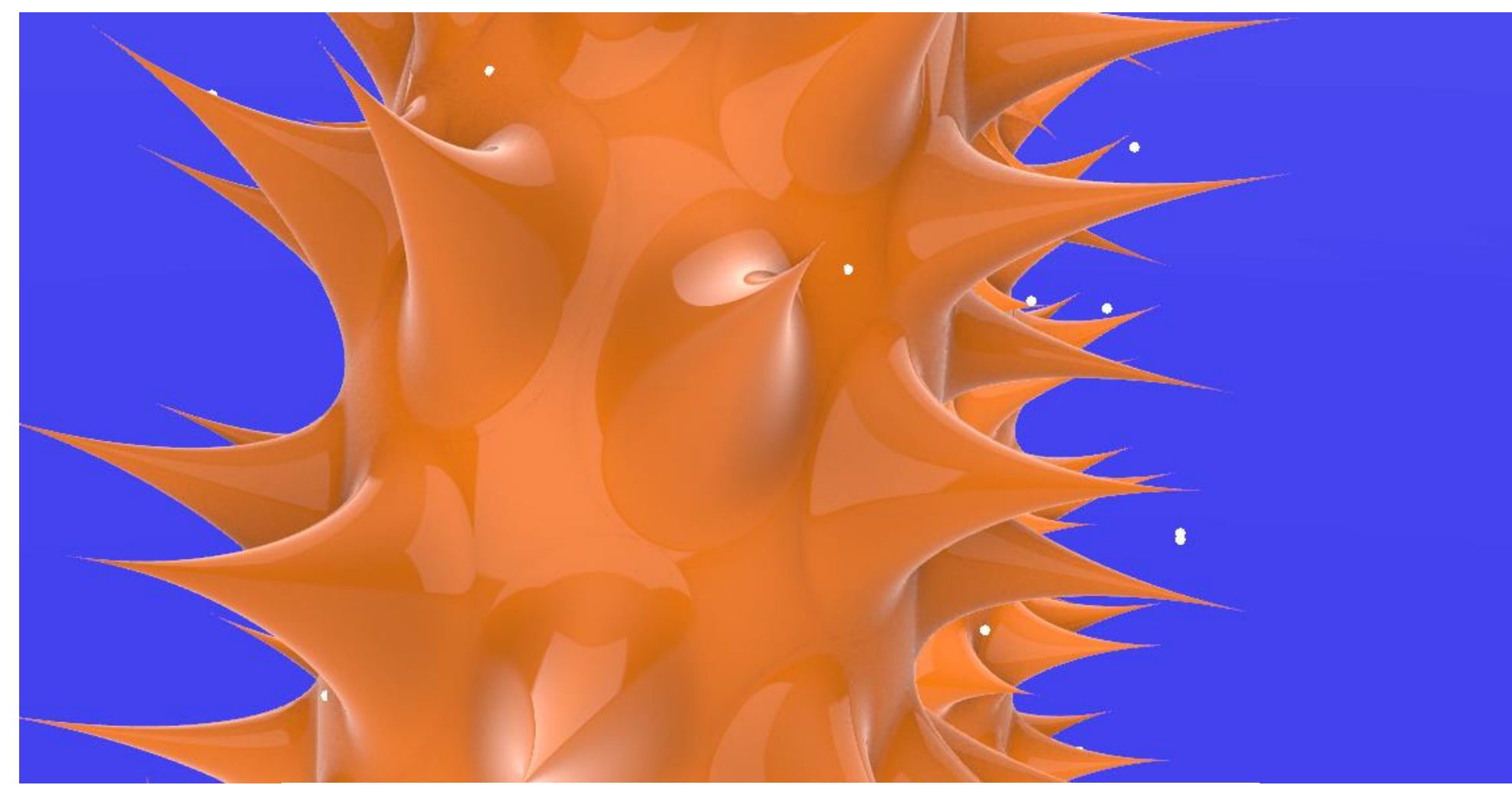
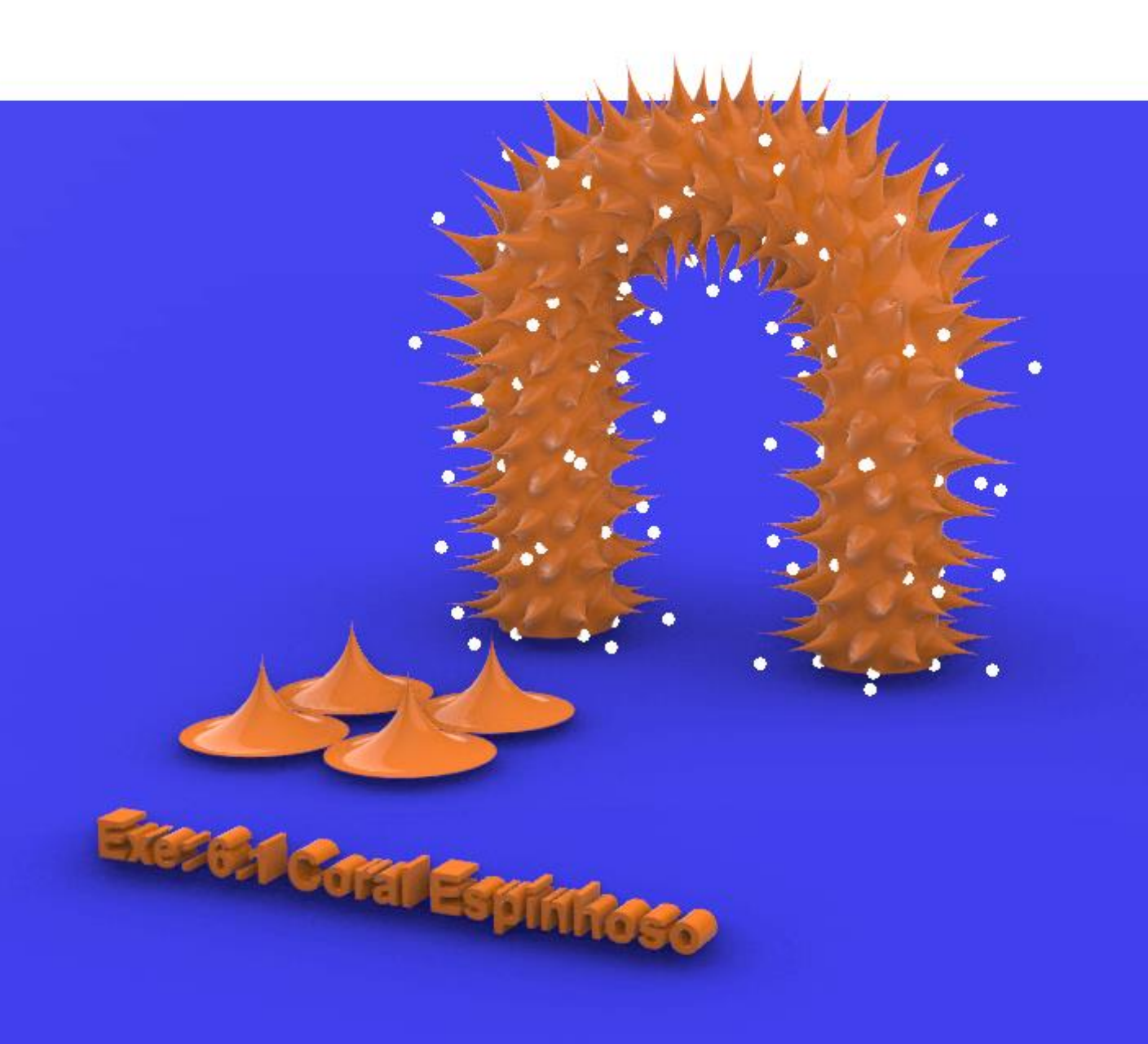

Exerc.7.1 Coral Espinhoso

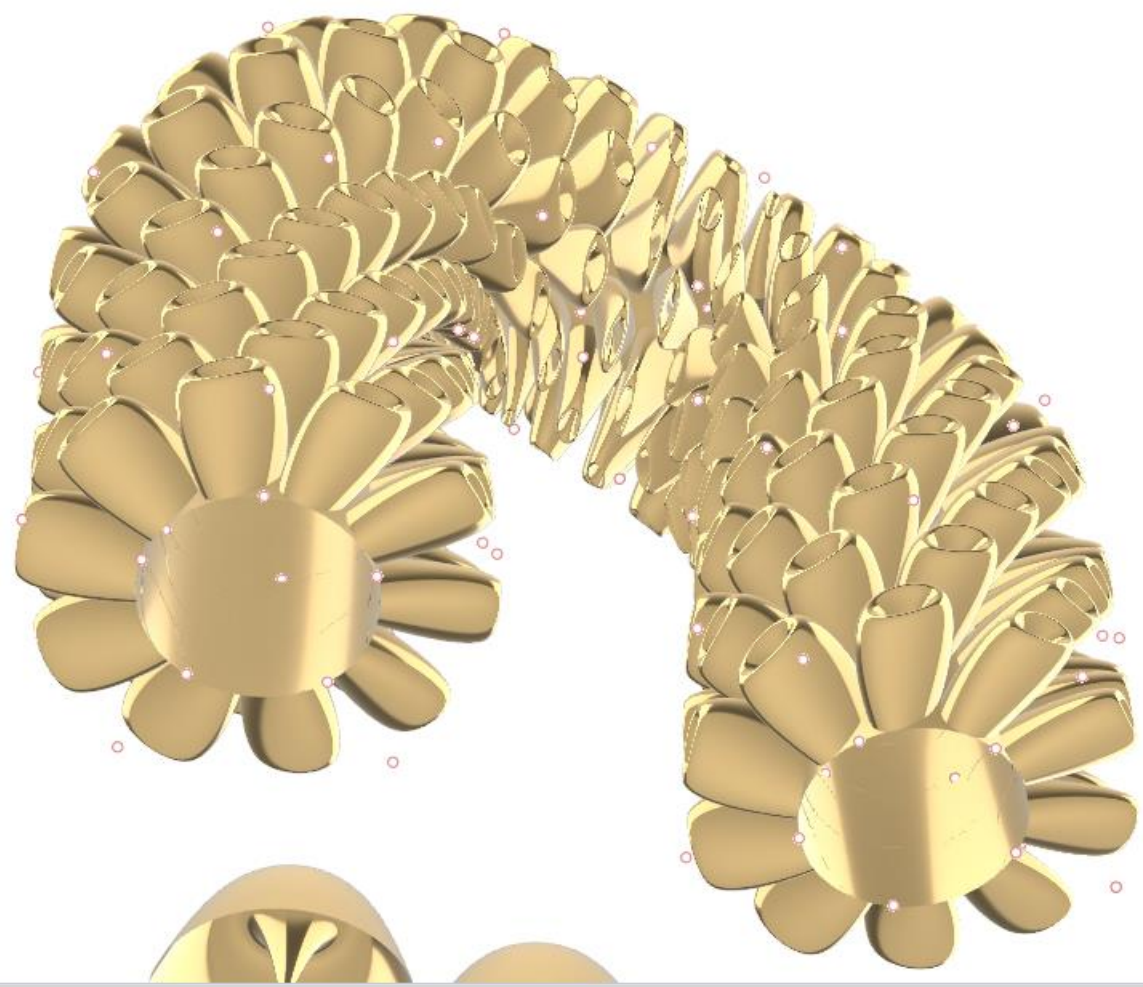
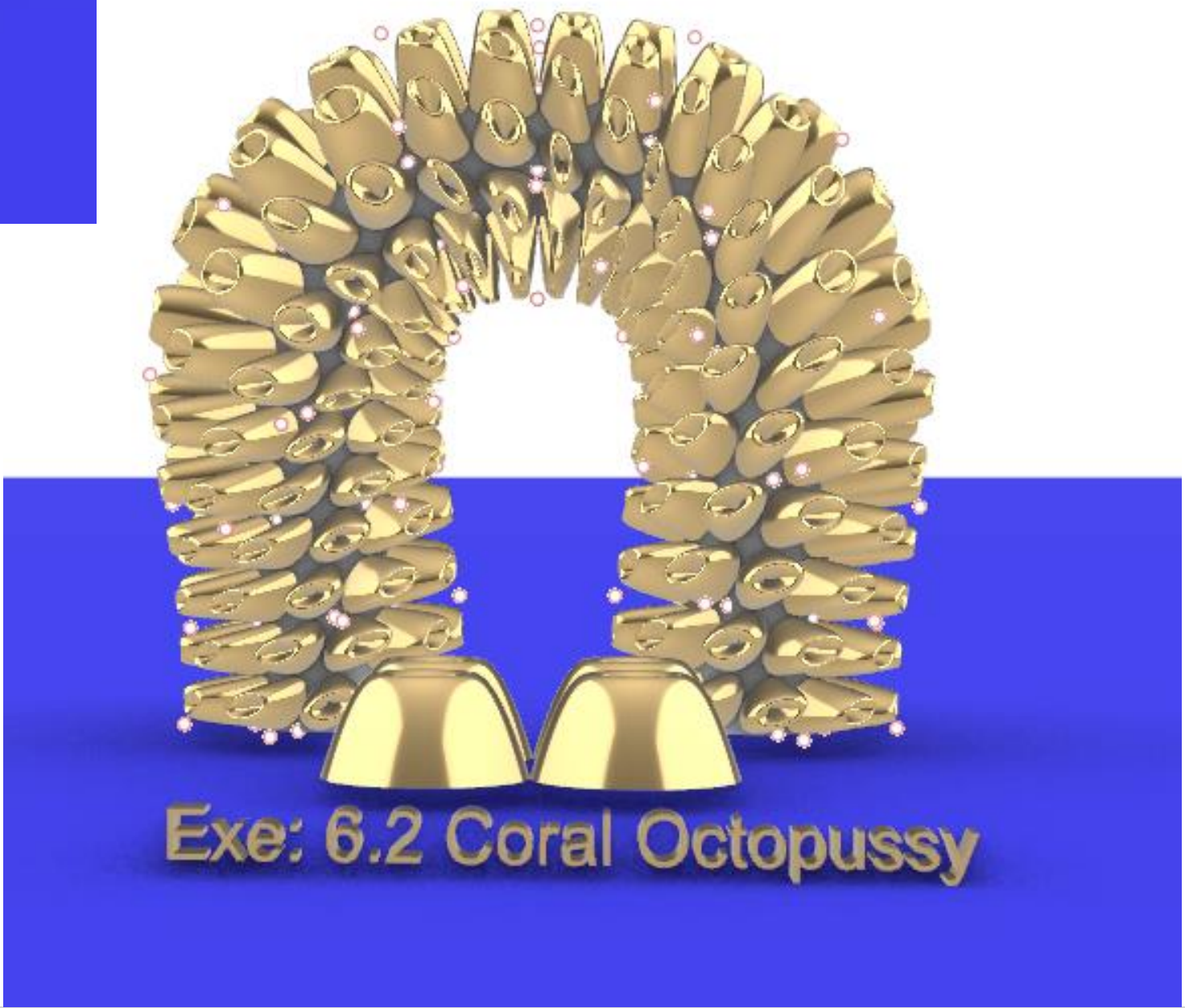
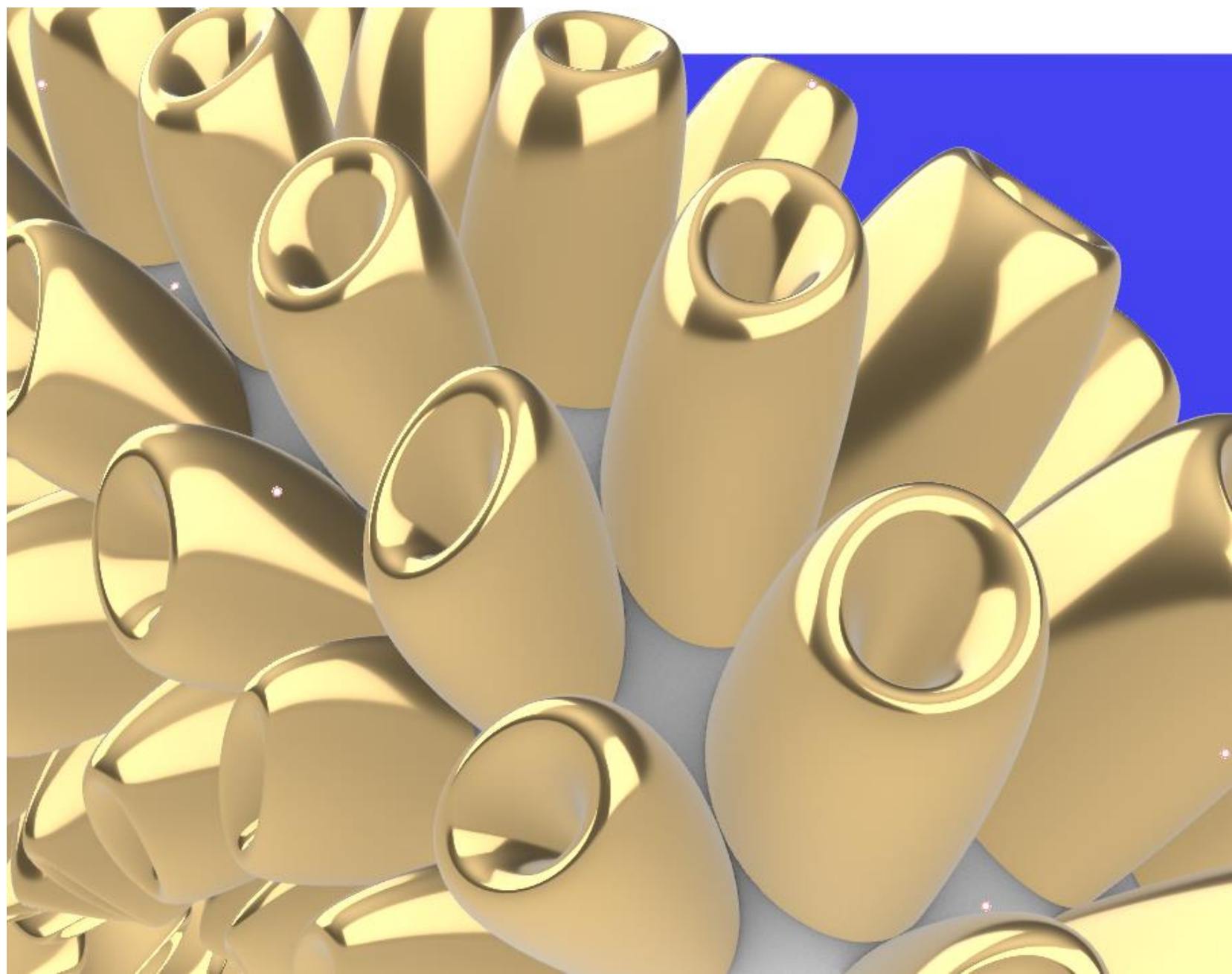
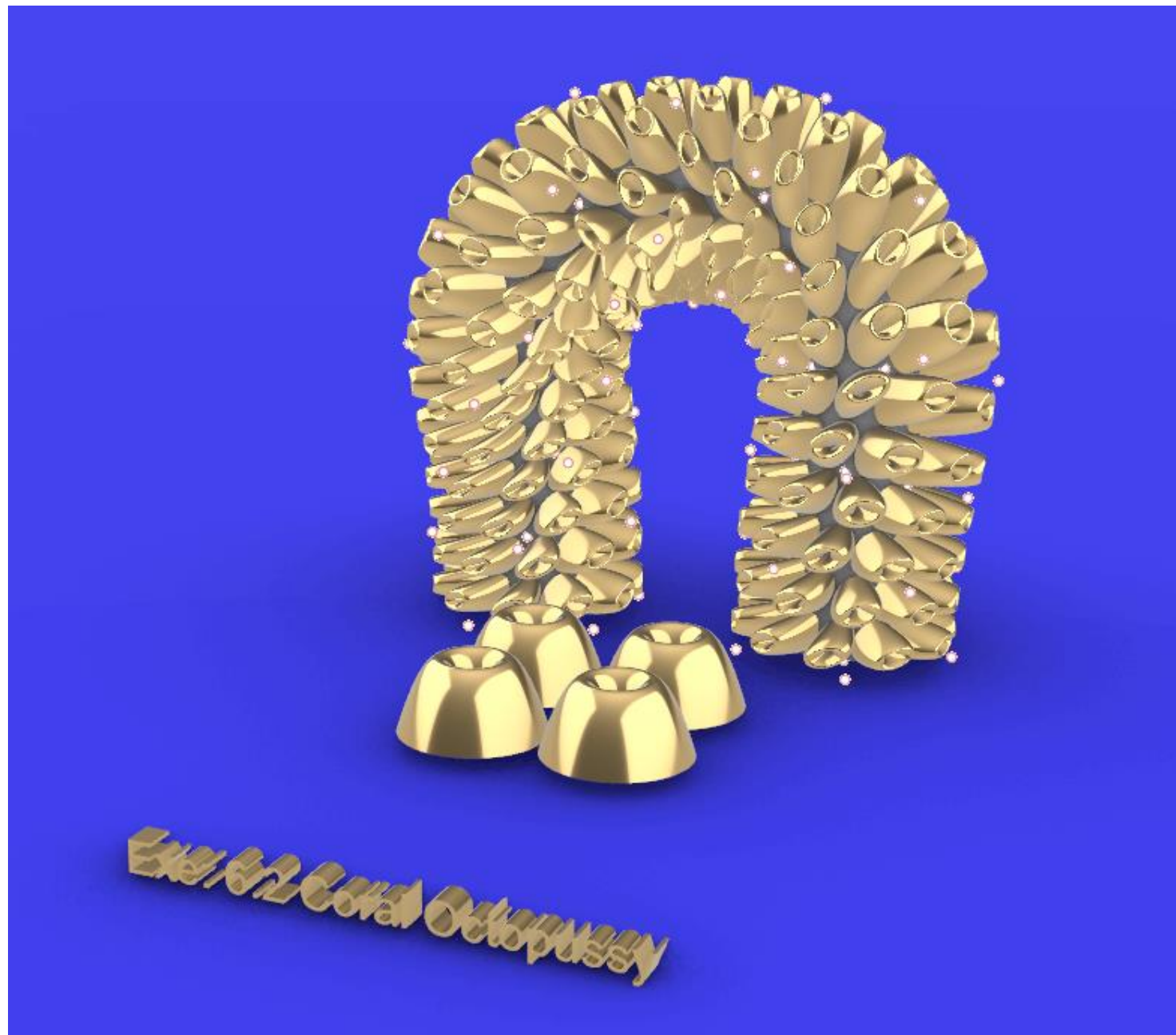

Exerc.7.2 Coral Octopussy

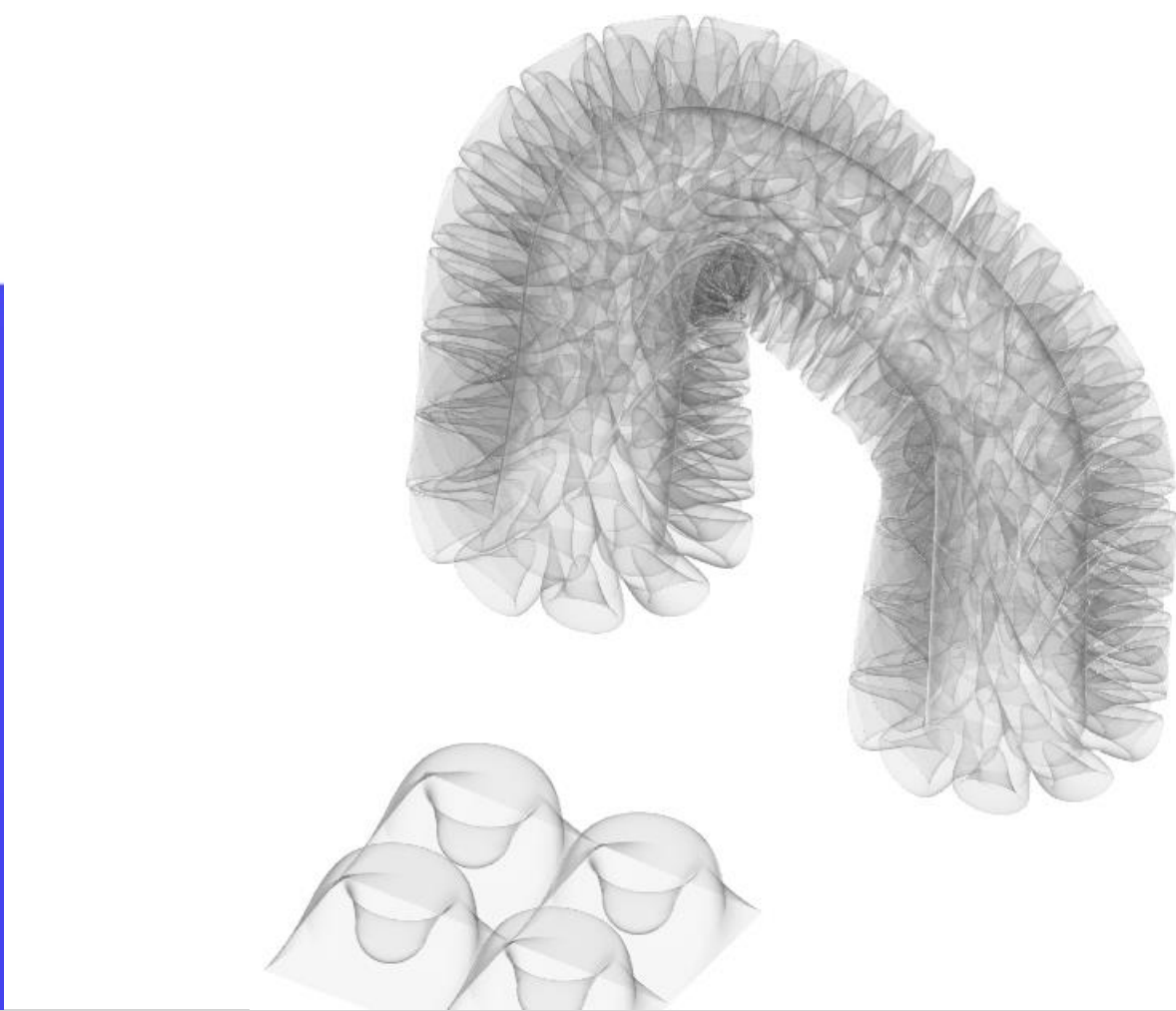
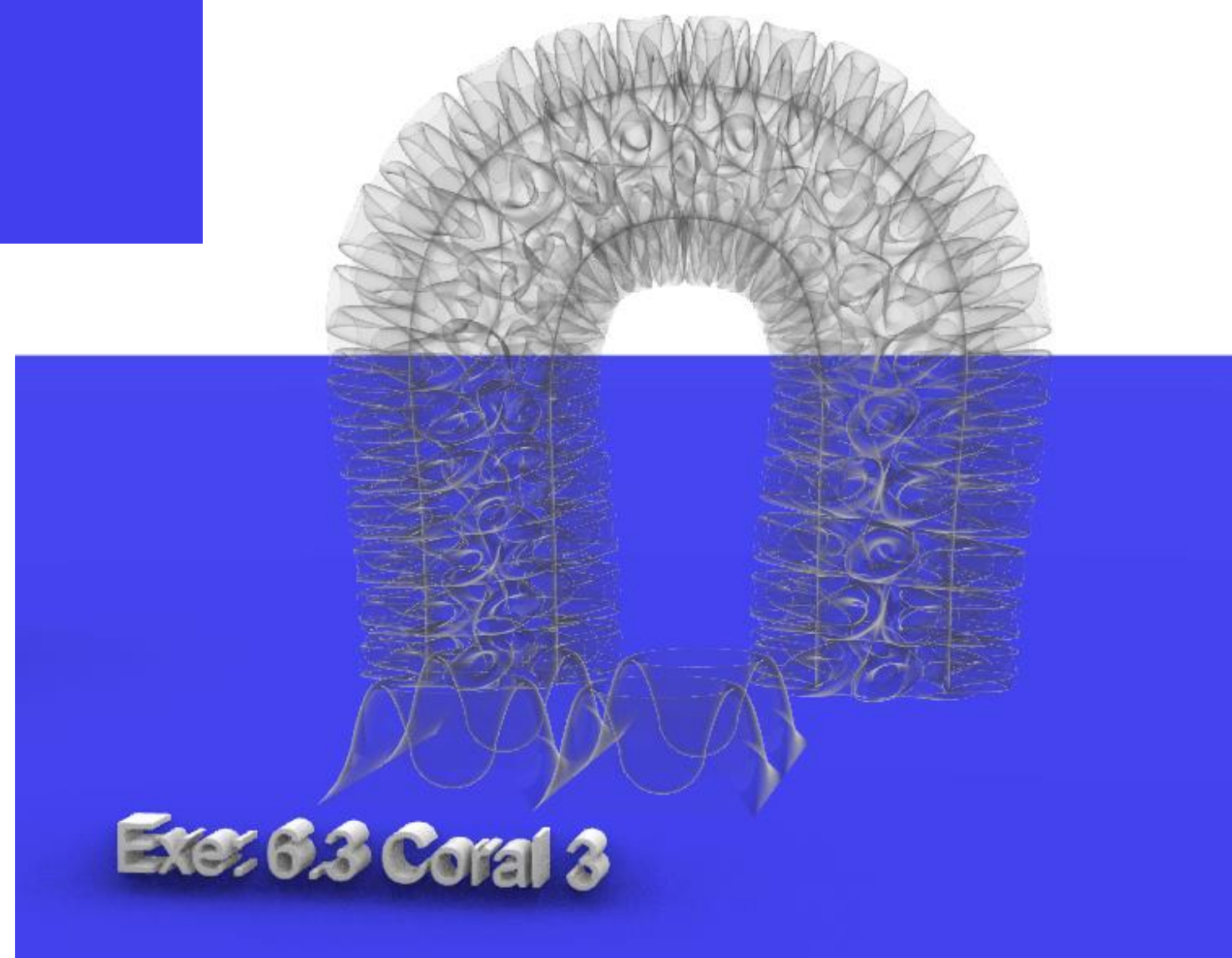
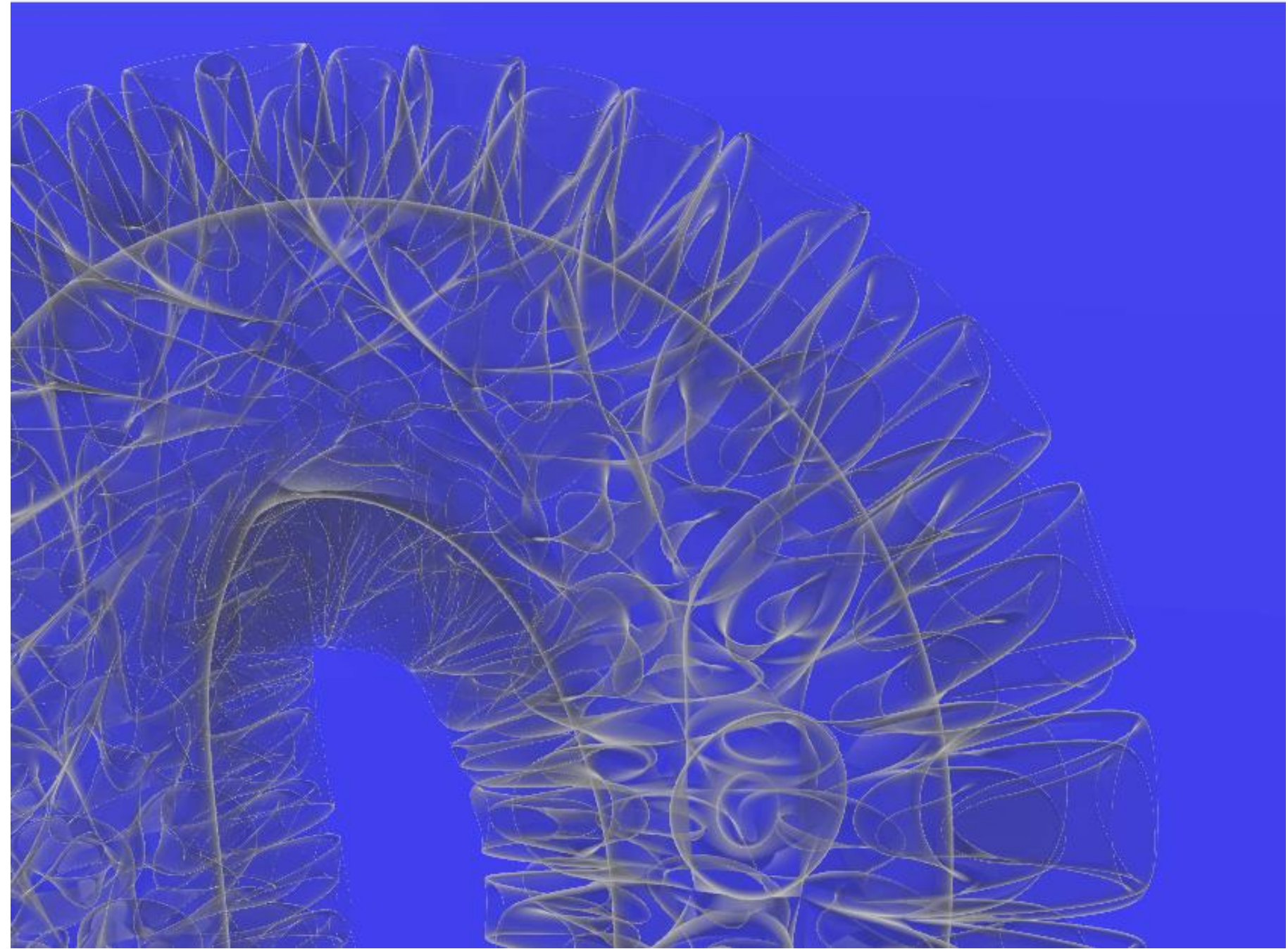
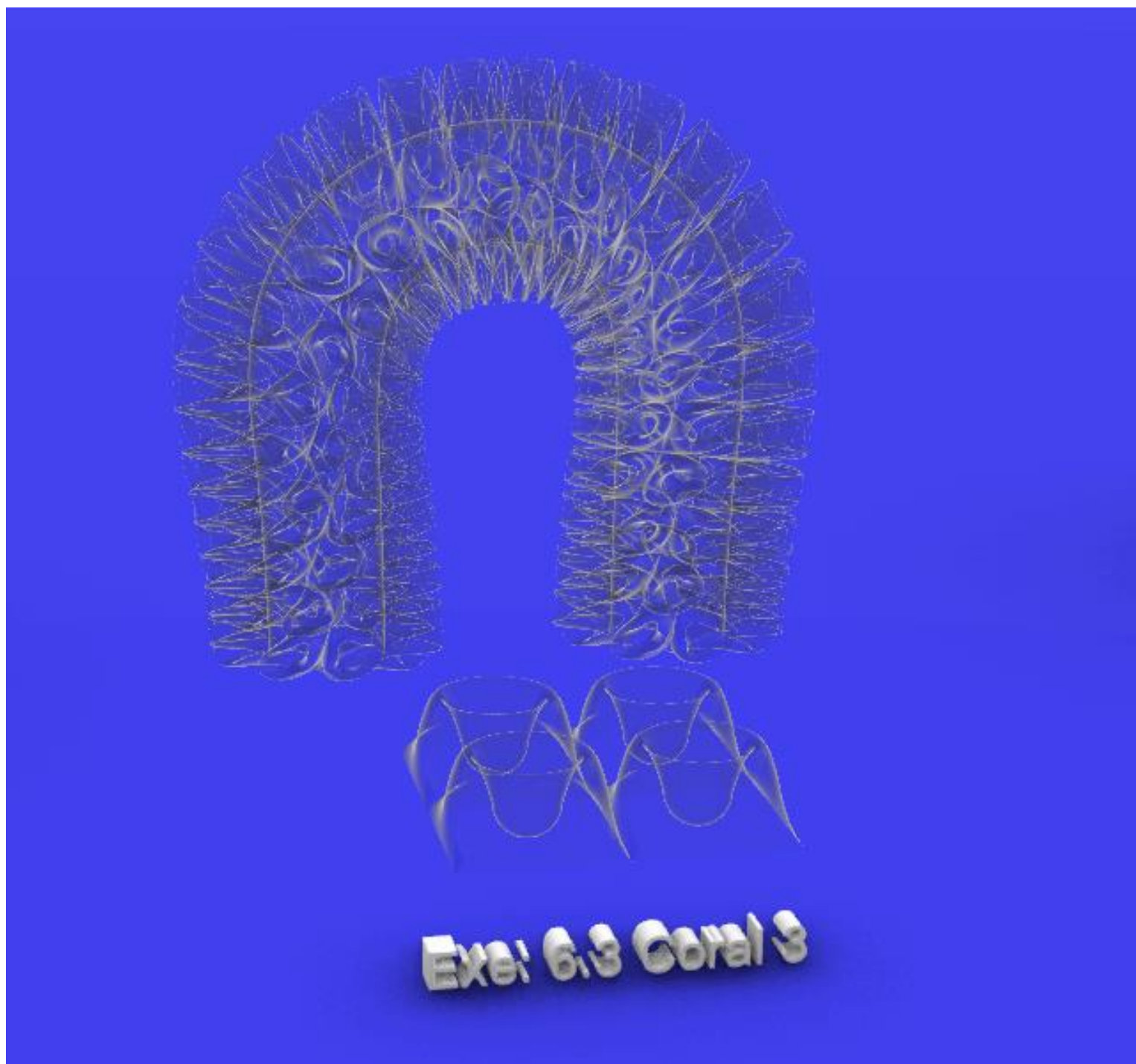

Exerc.7.3 Coral 3

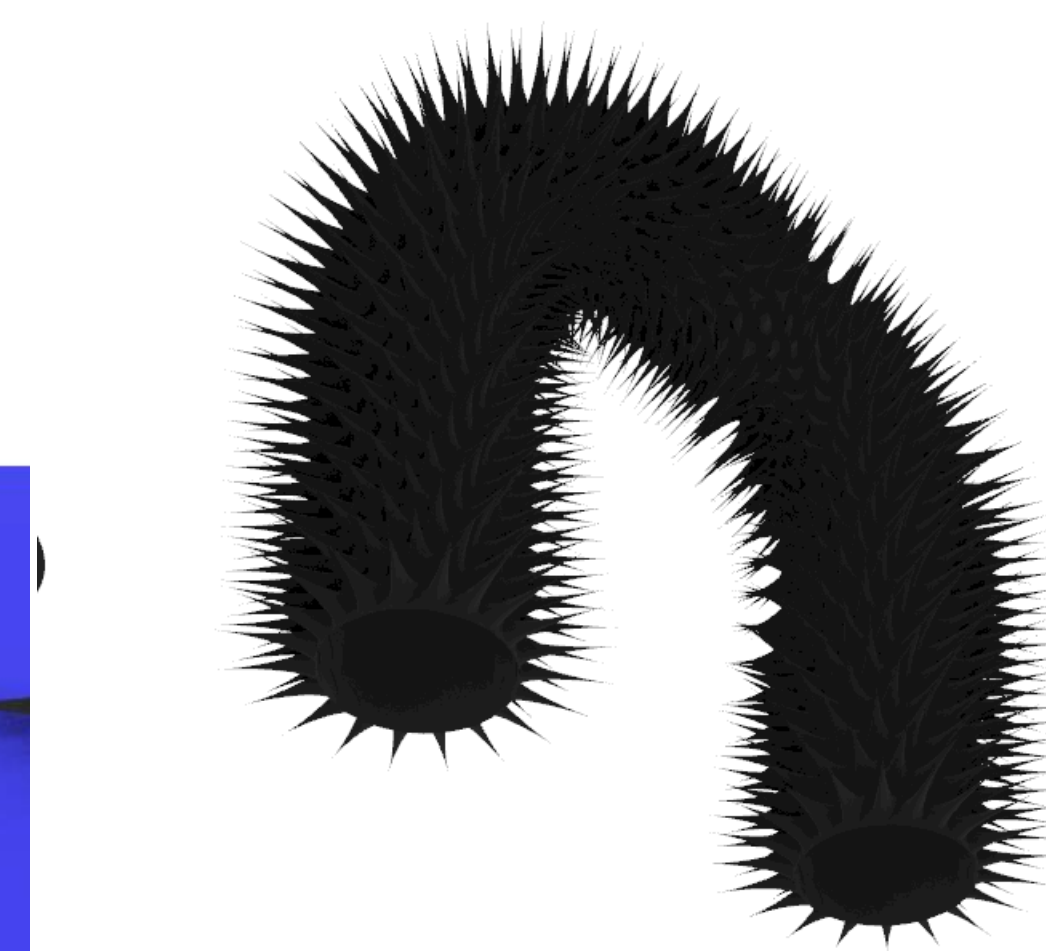
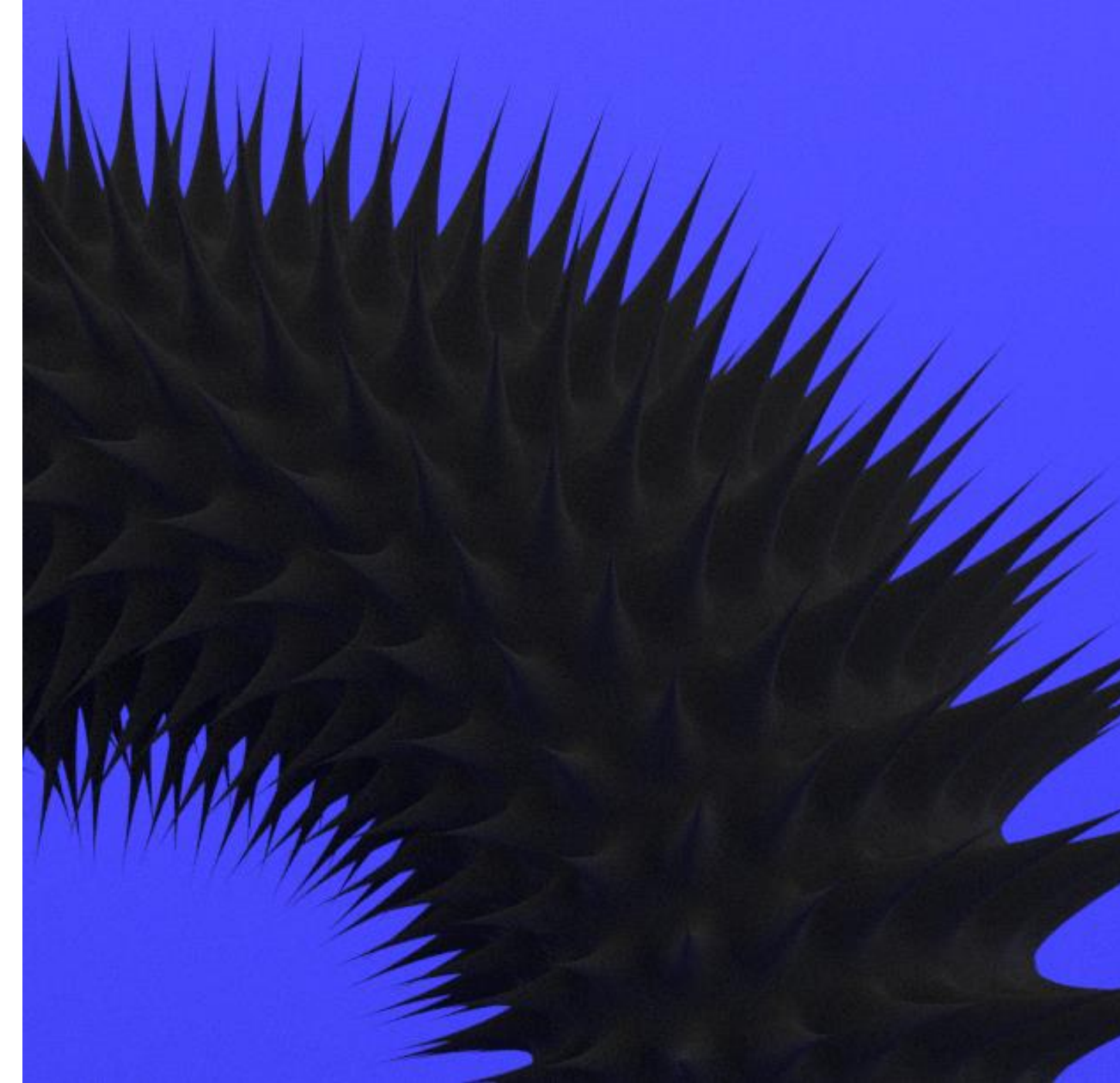
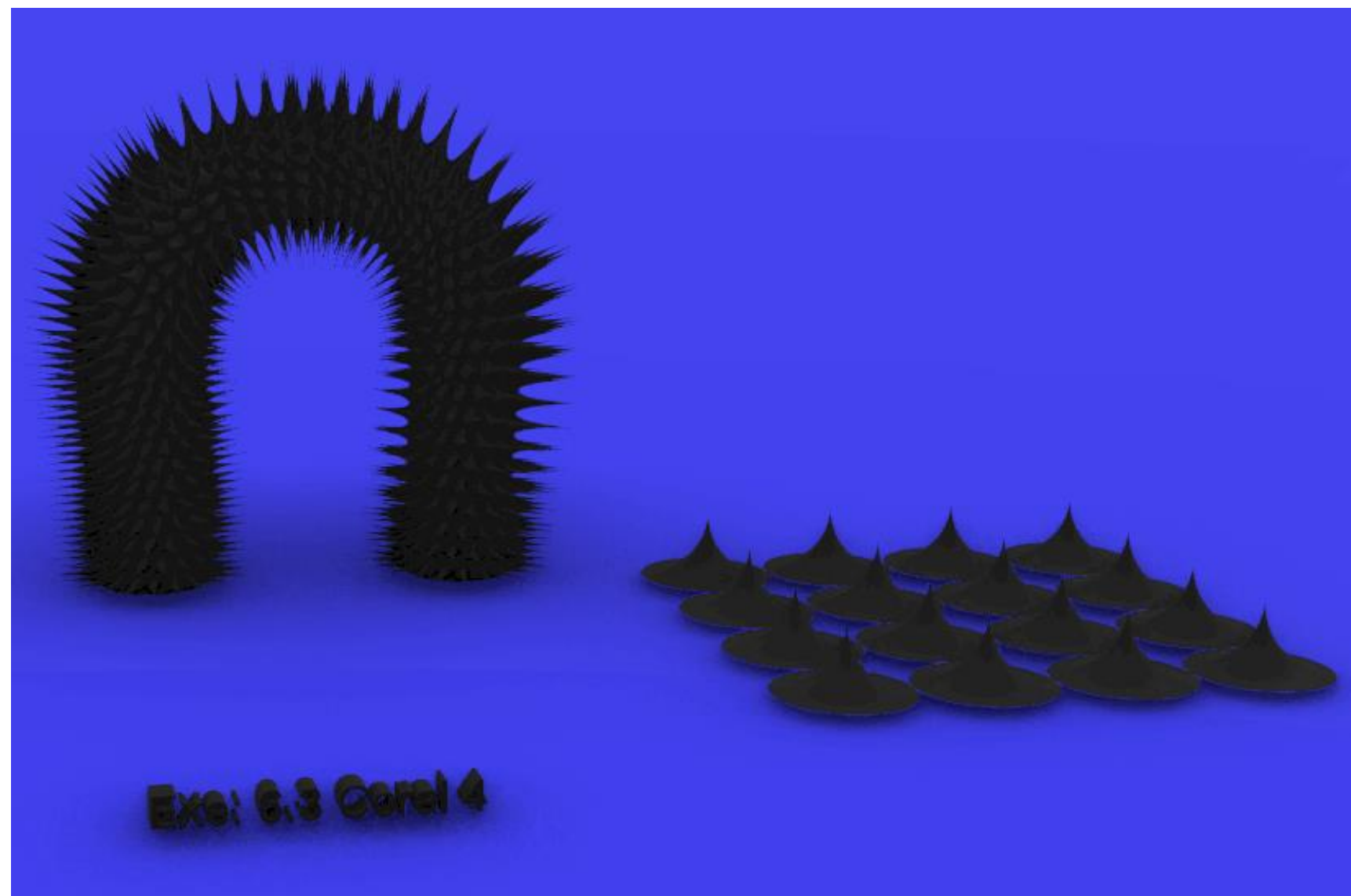

Exerc.7.4 Coral 4



Exerc.8 Anémonas

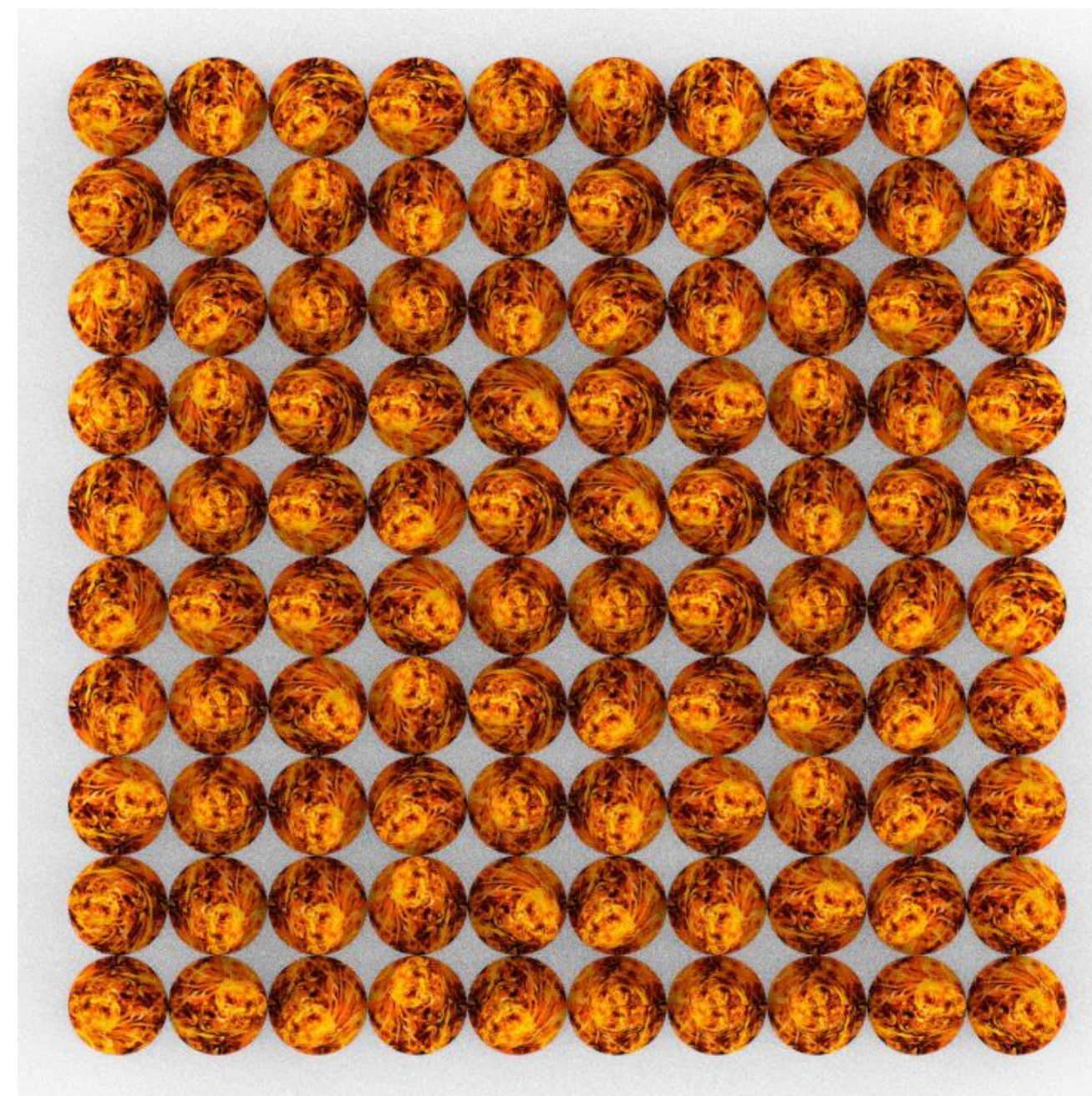

Exerc.8 Anémonas

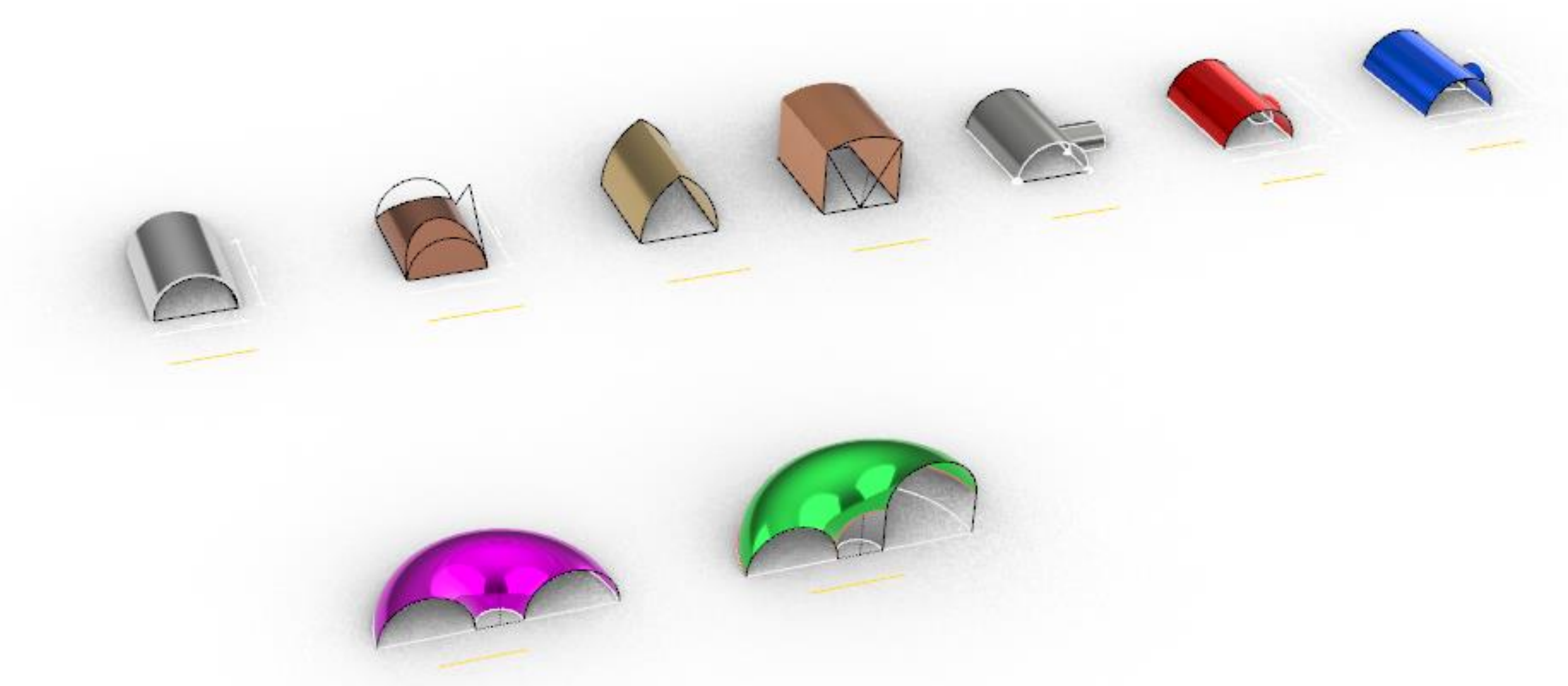

Exerc.9.0 Abobadas

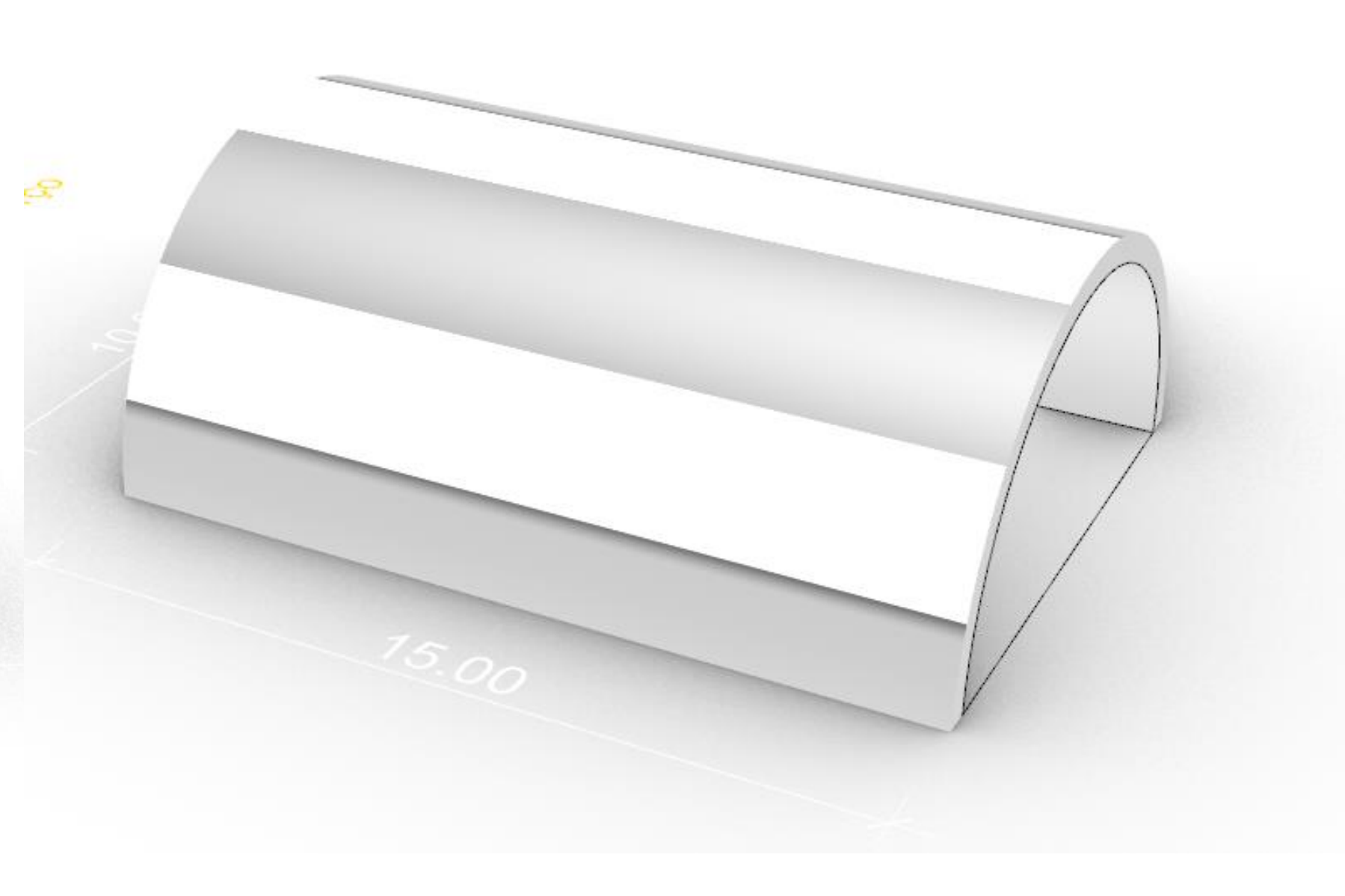

Exerc.9.1 Abobada de Berço

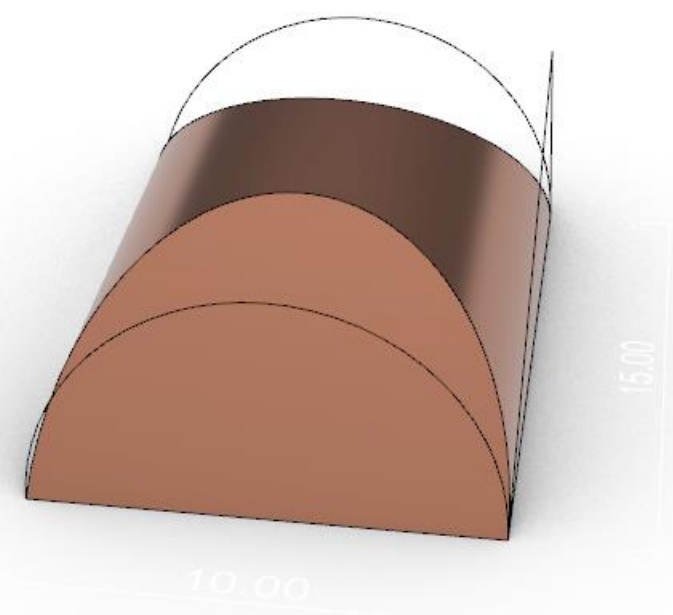

7.2 Abóbada de Cisterna

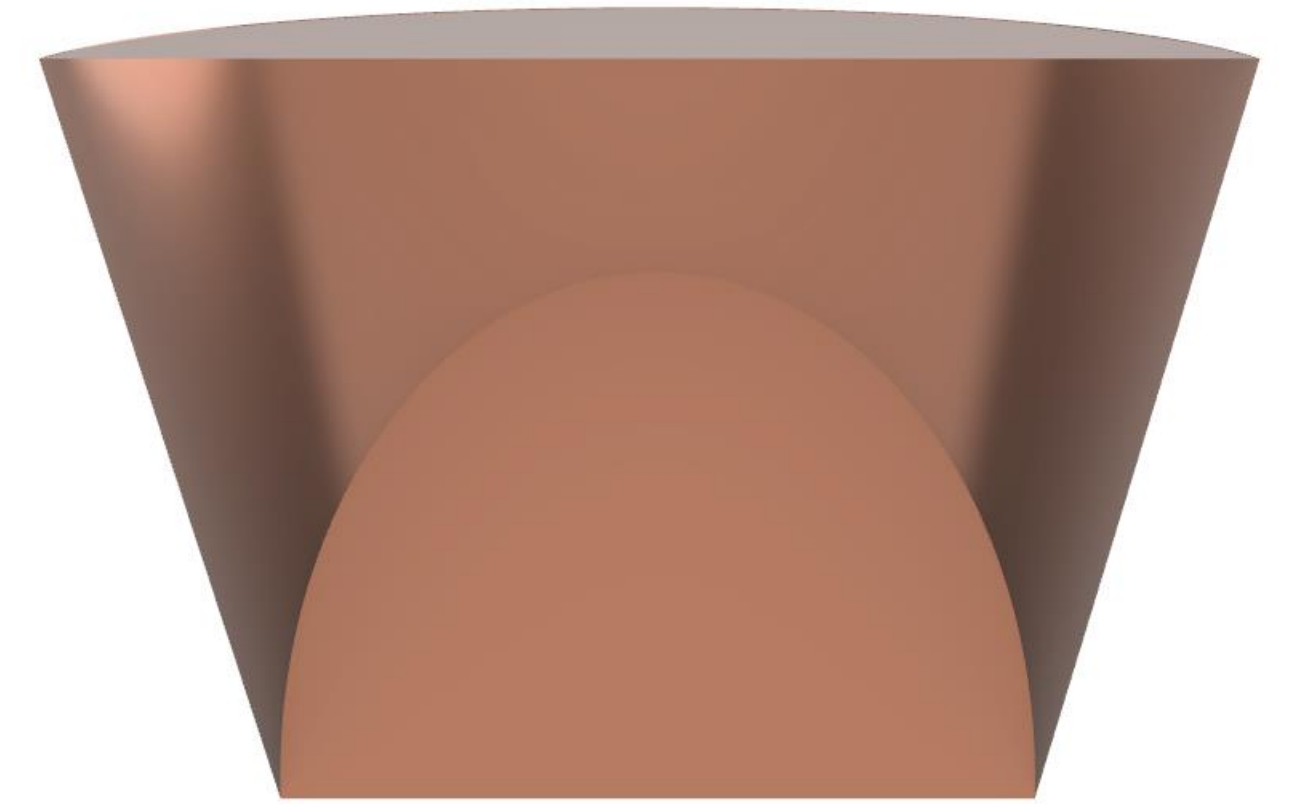
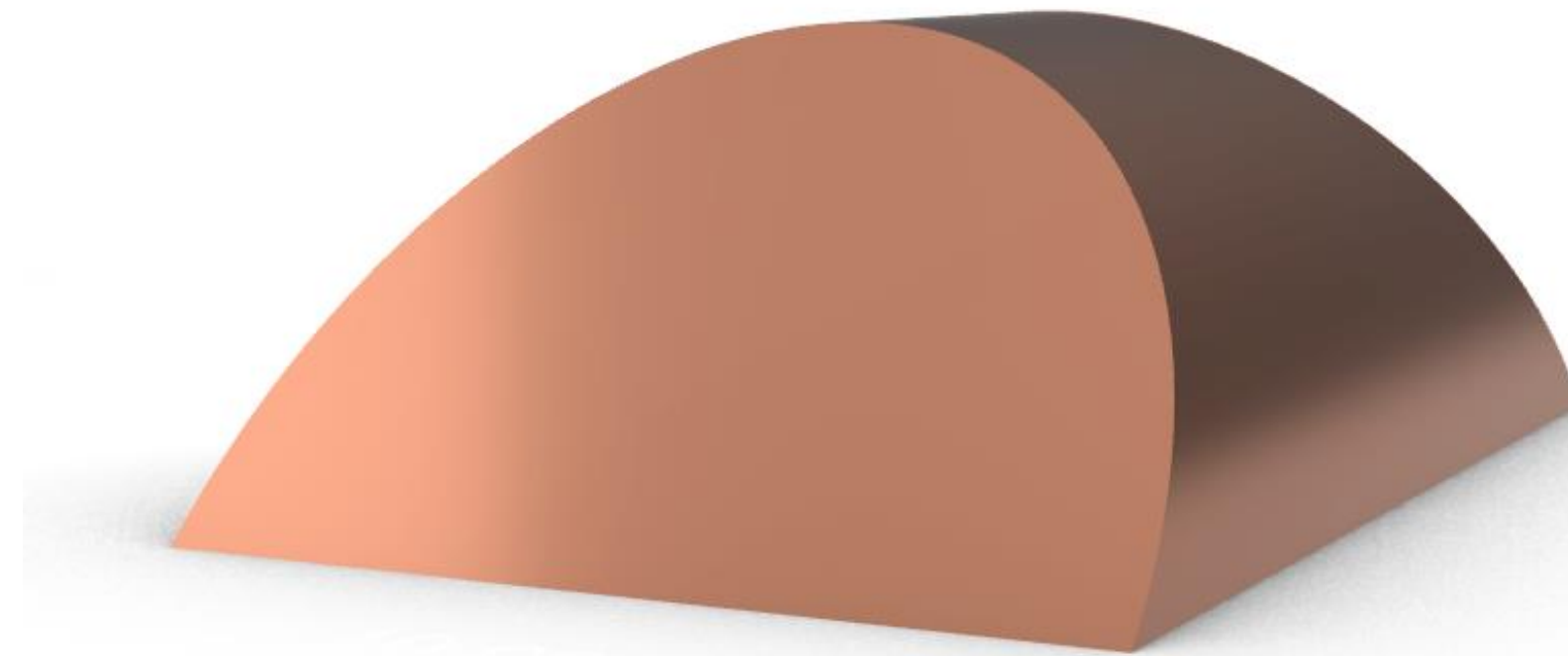

Exerc.9.2 Abobada de Cisterna

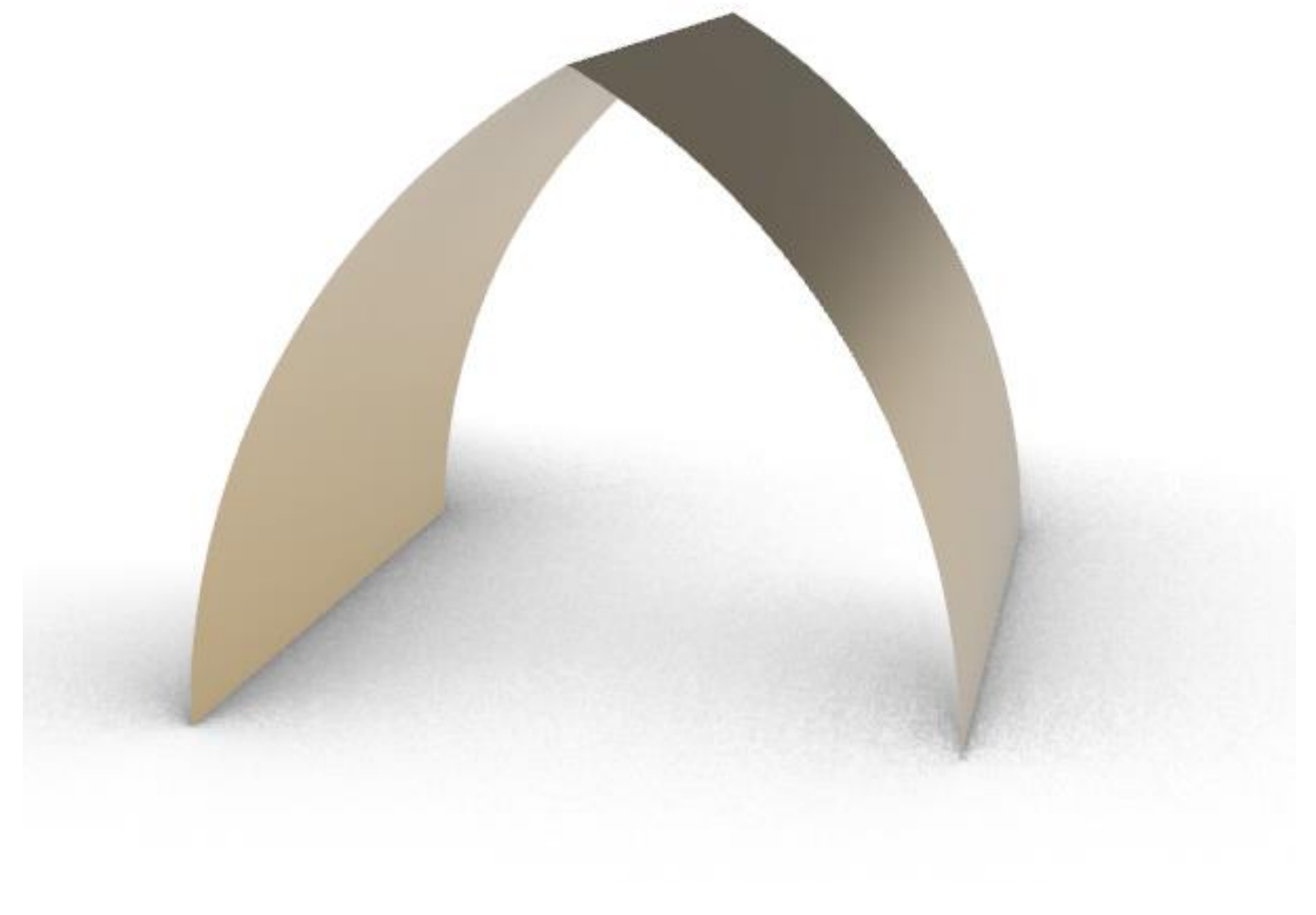
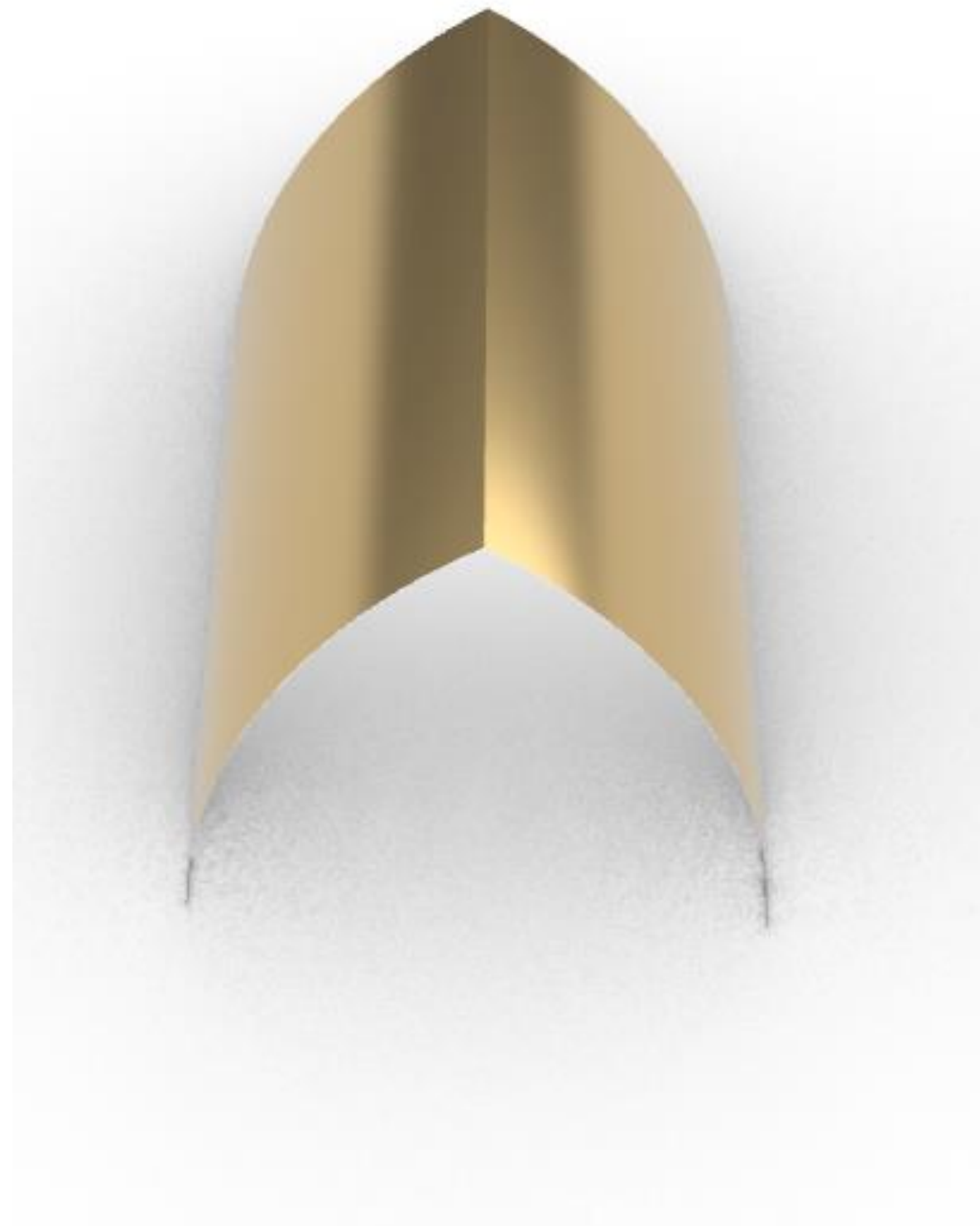
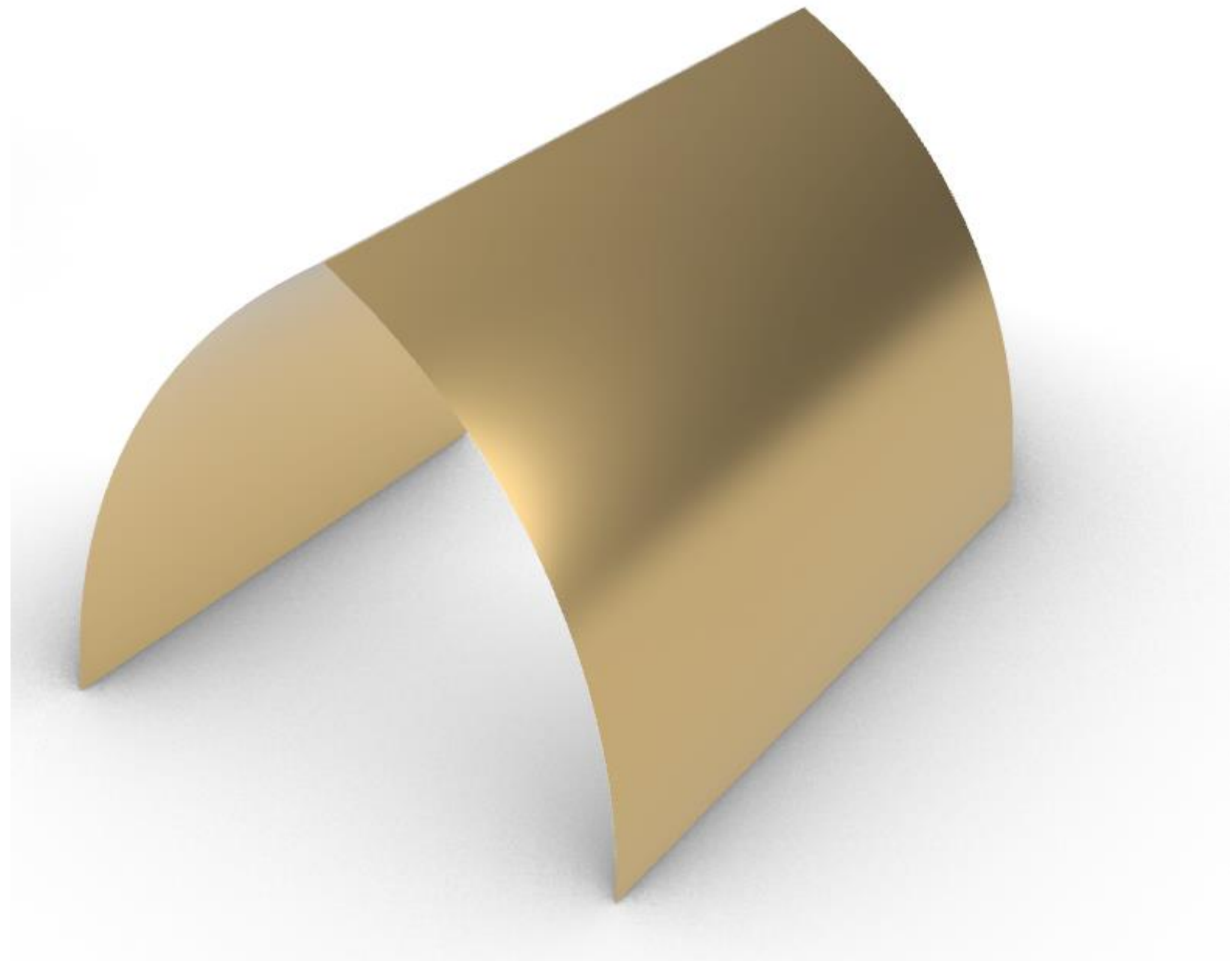

7.3 Abóbada de Ogiva

Exerc.9.3 Abobada de Ogiva

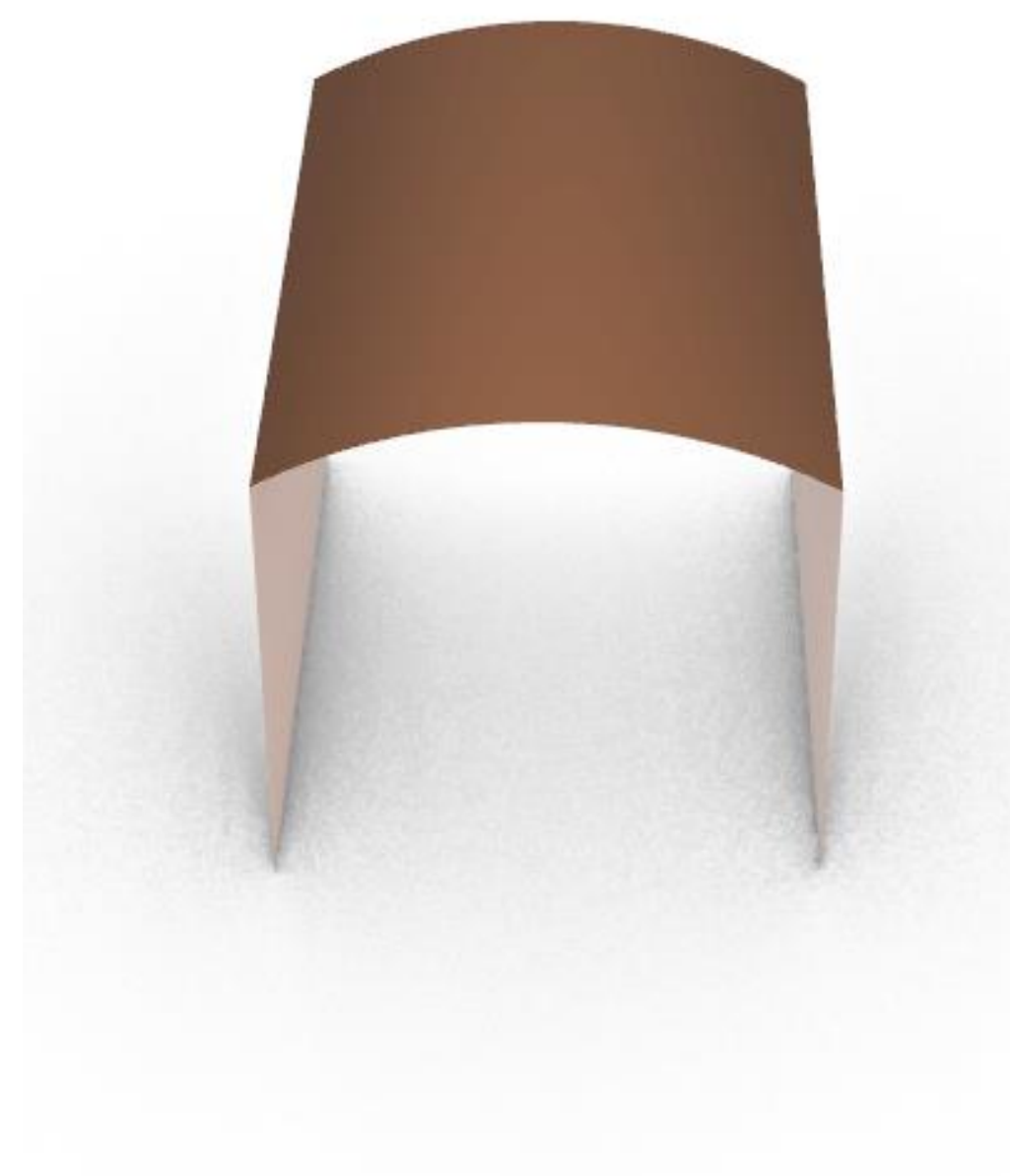
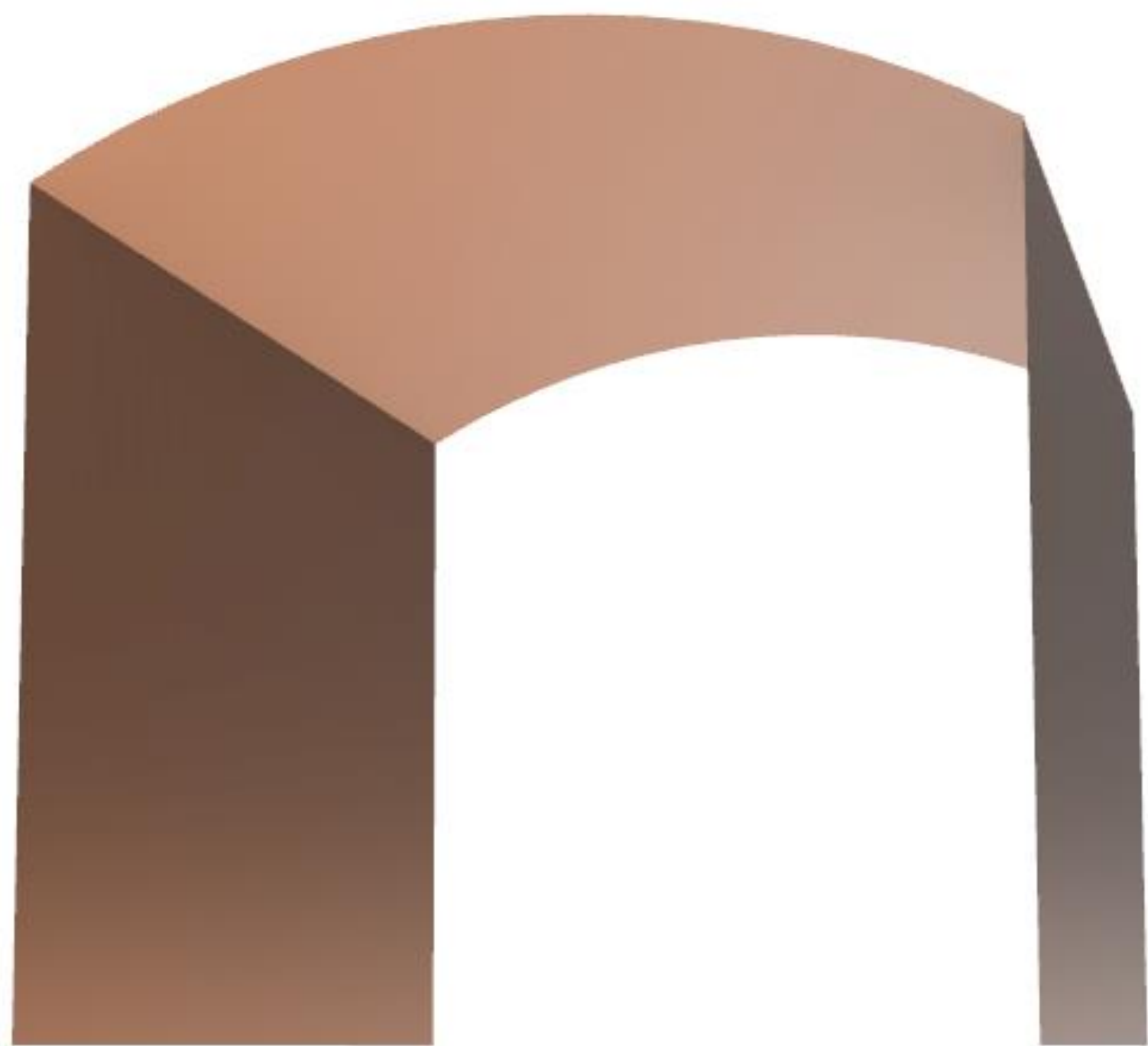

7.4 Abóbada Abatida

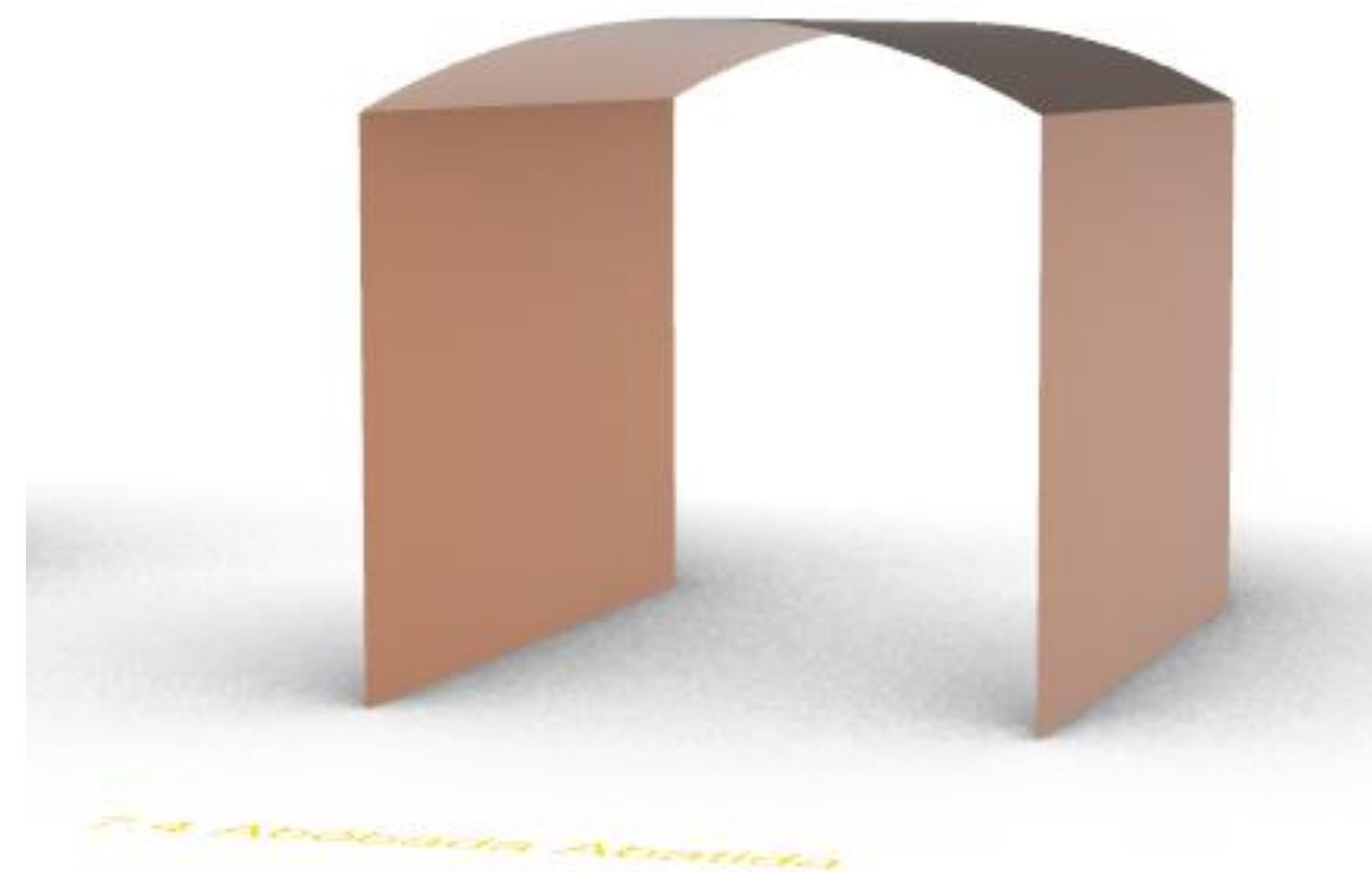

Exerc.9.4 Abobada Abatida

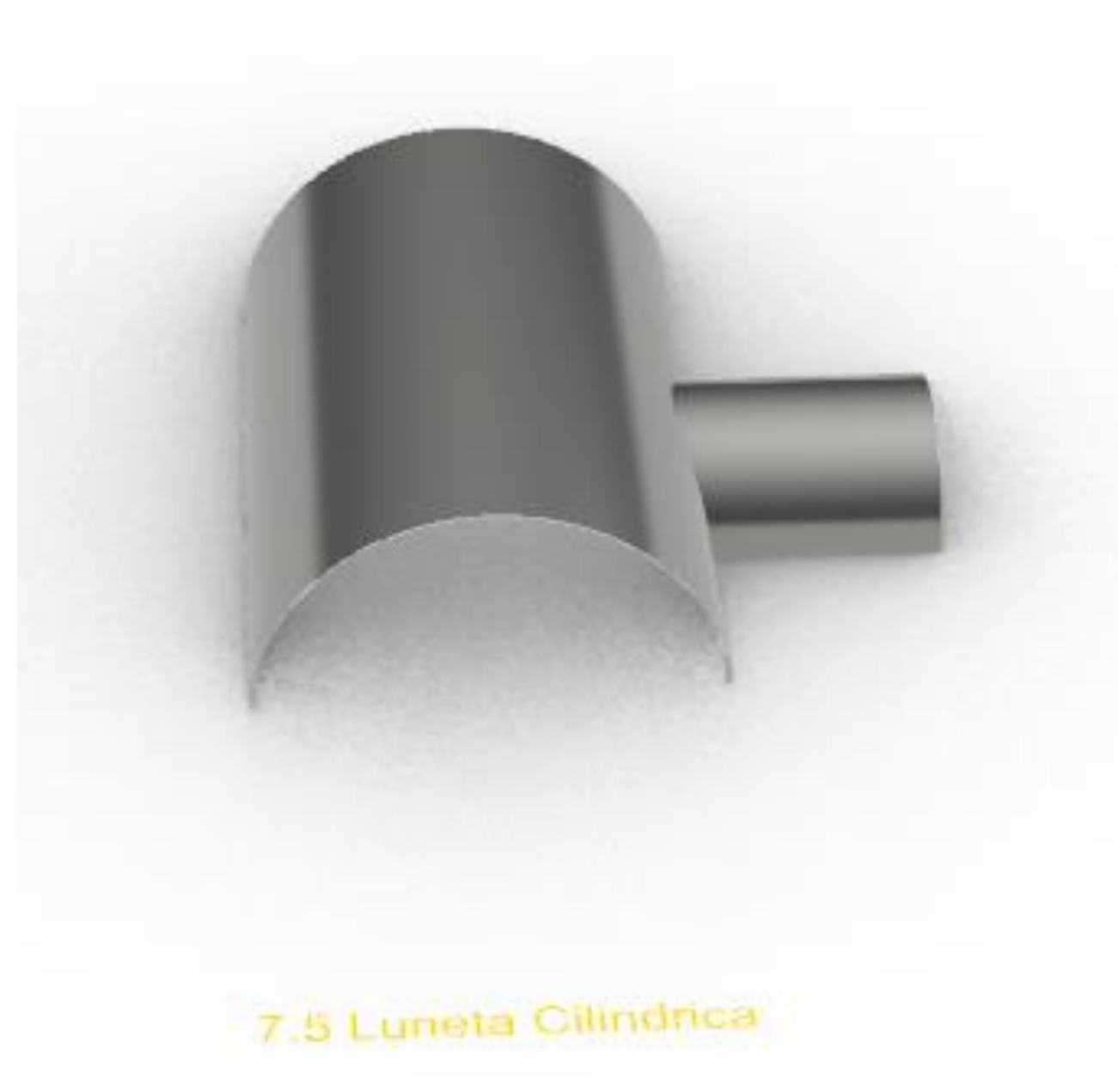
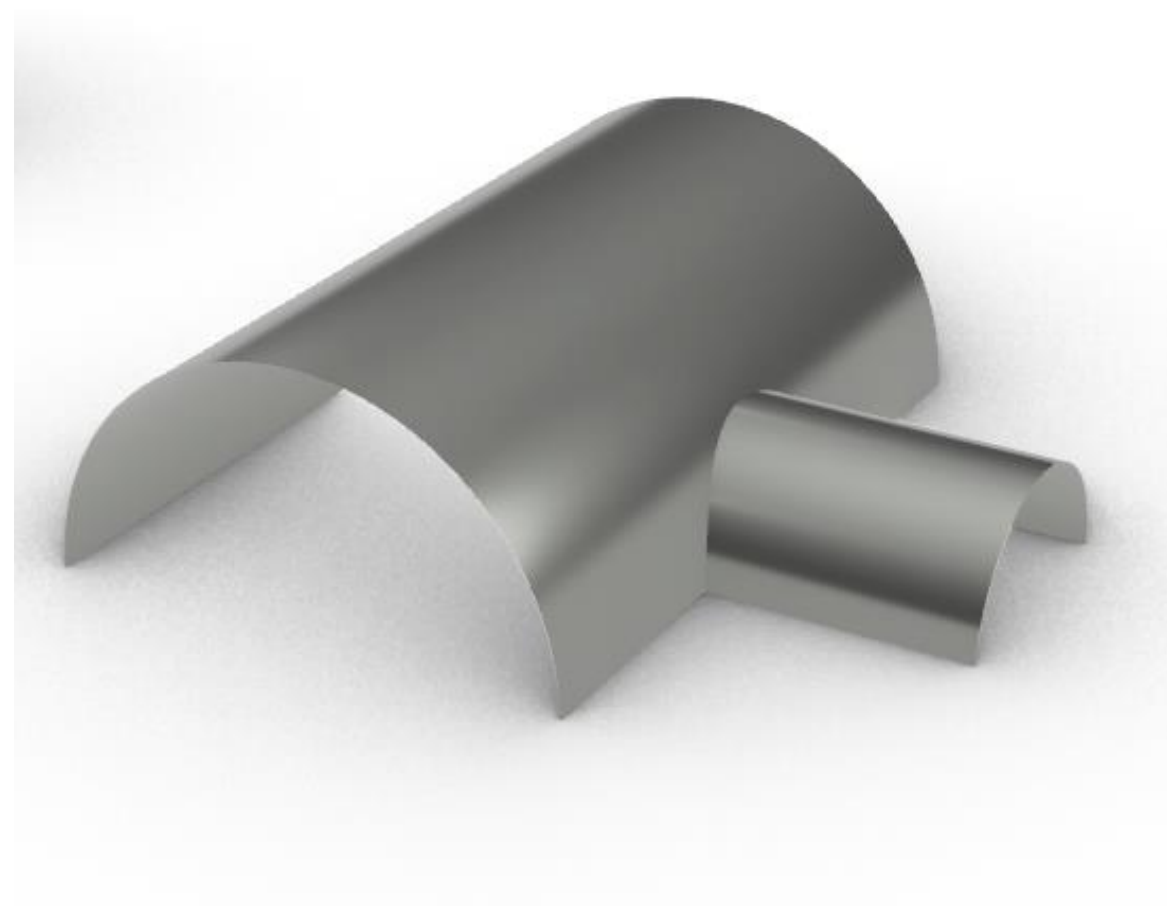

Exerc.9.5 Abobada Cilindrica

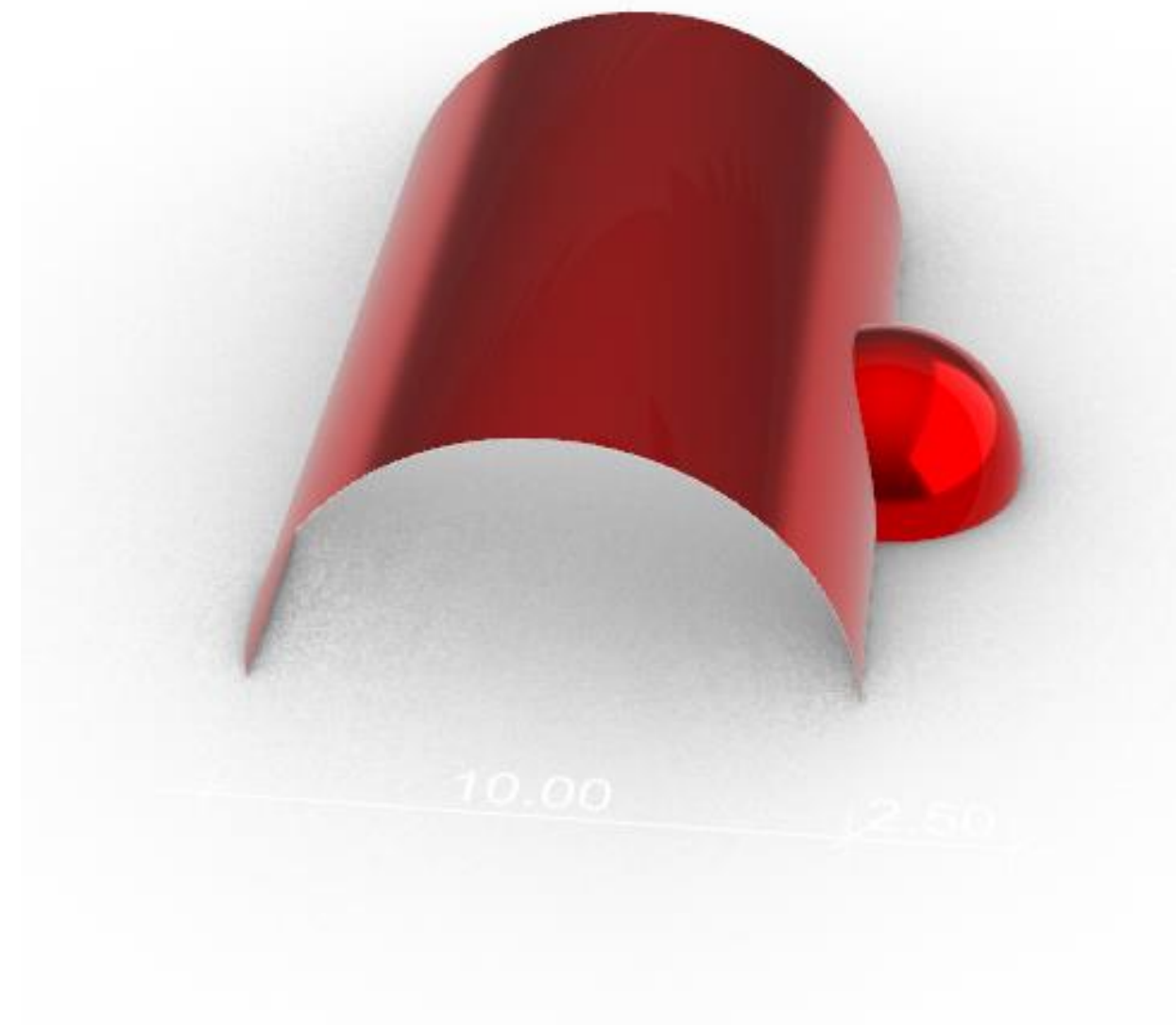
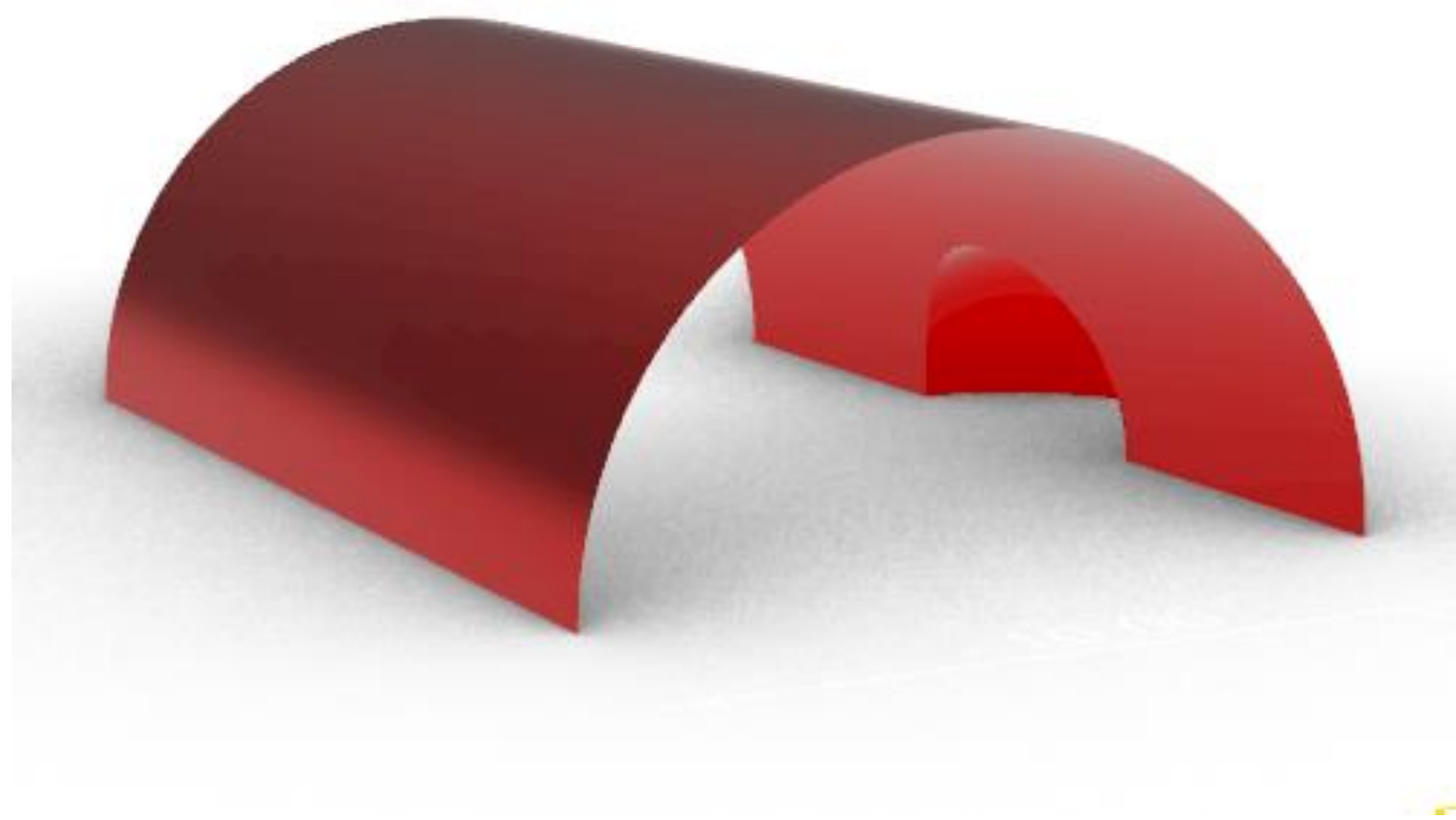

7.6 Luneta Esférica



Exerc.9.6 Luneta Esférica

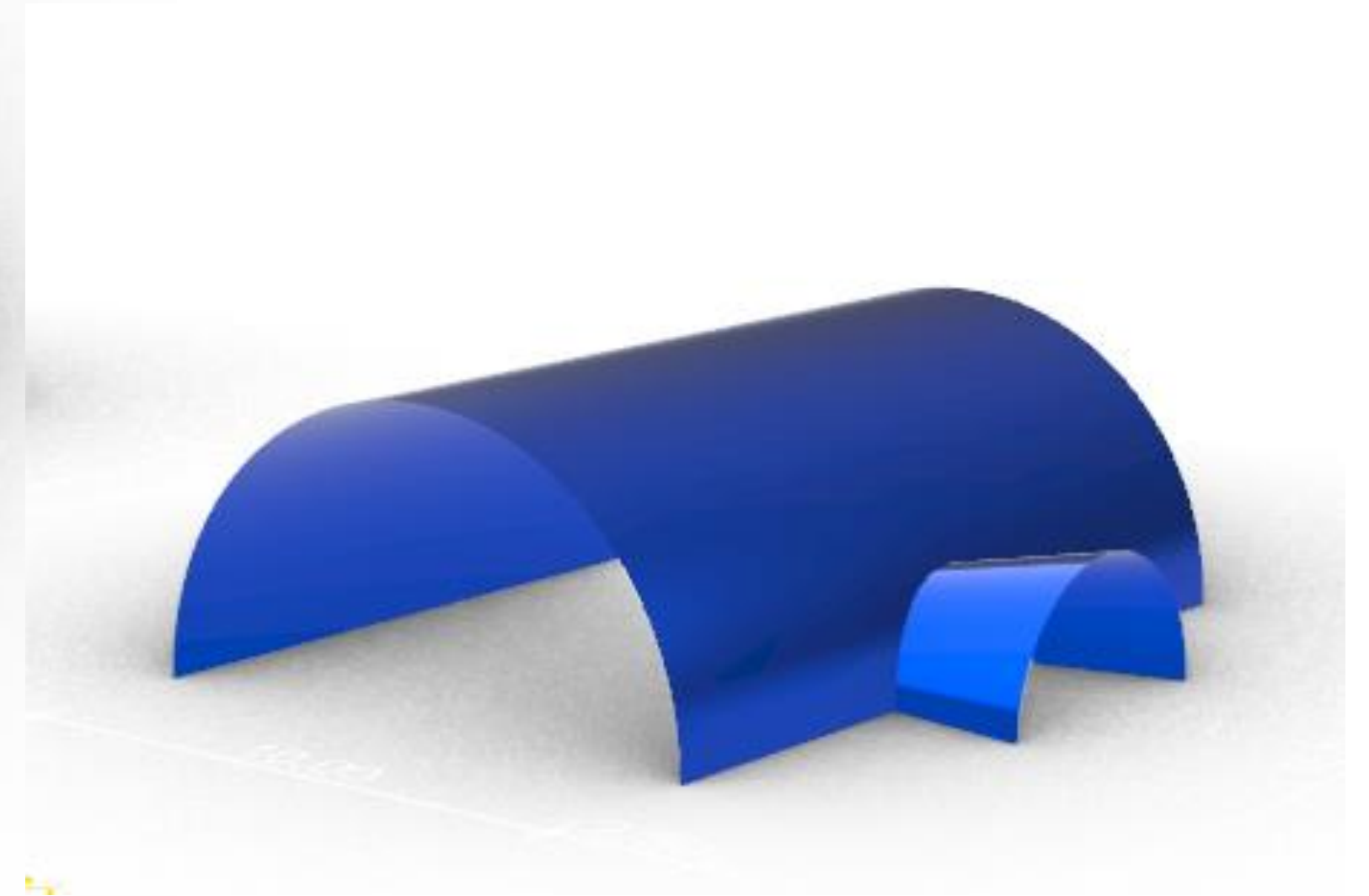
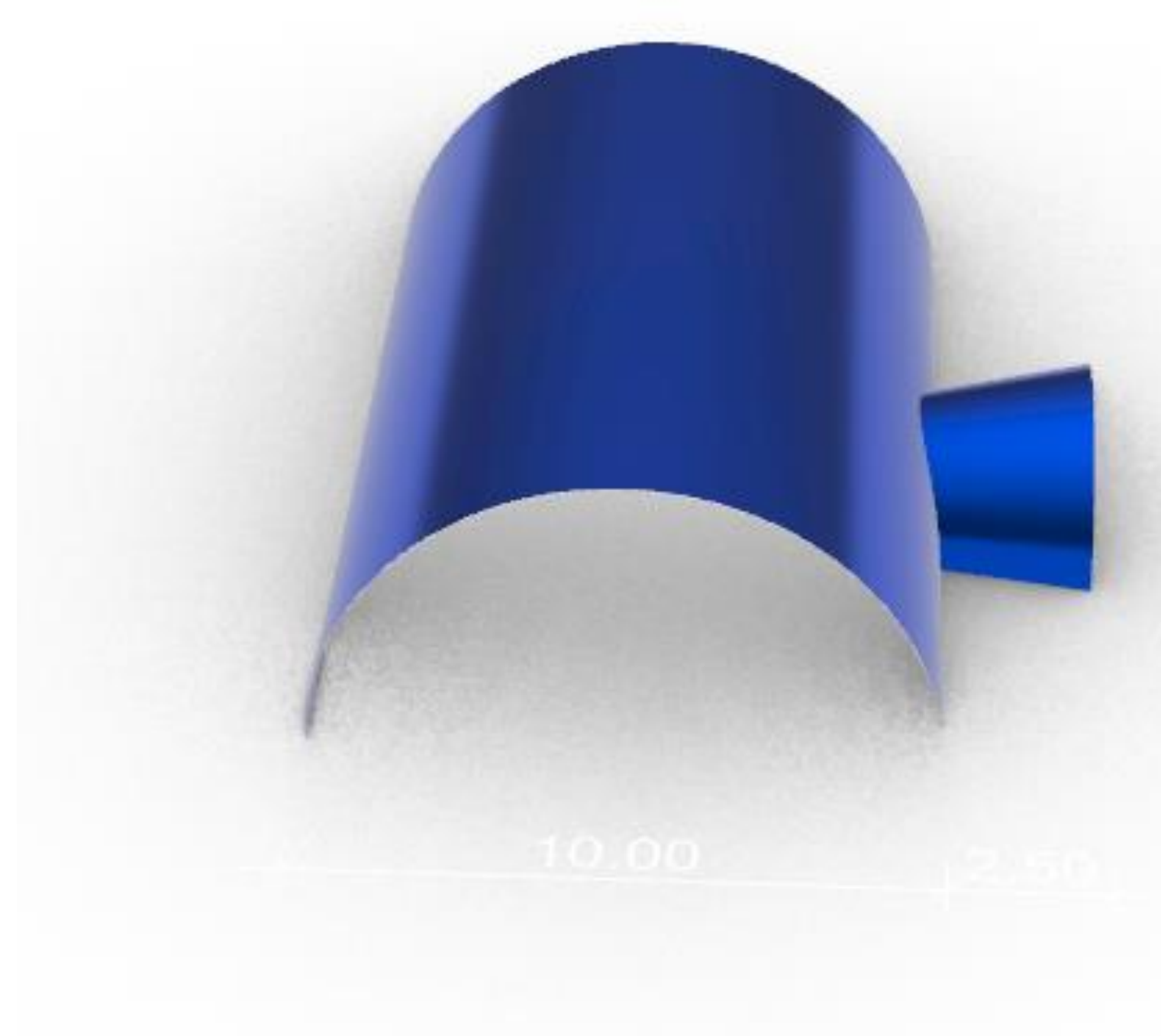

7.7 Luneta Cónica

Exerc.9.7 Luneta Conica

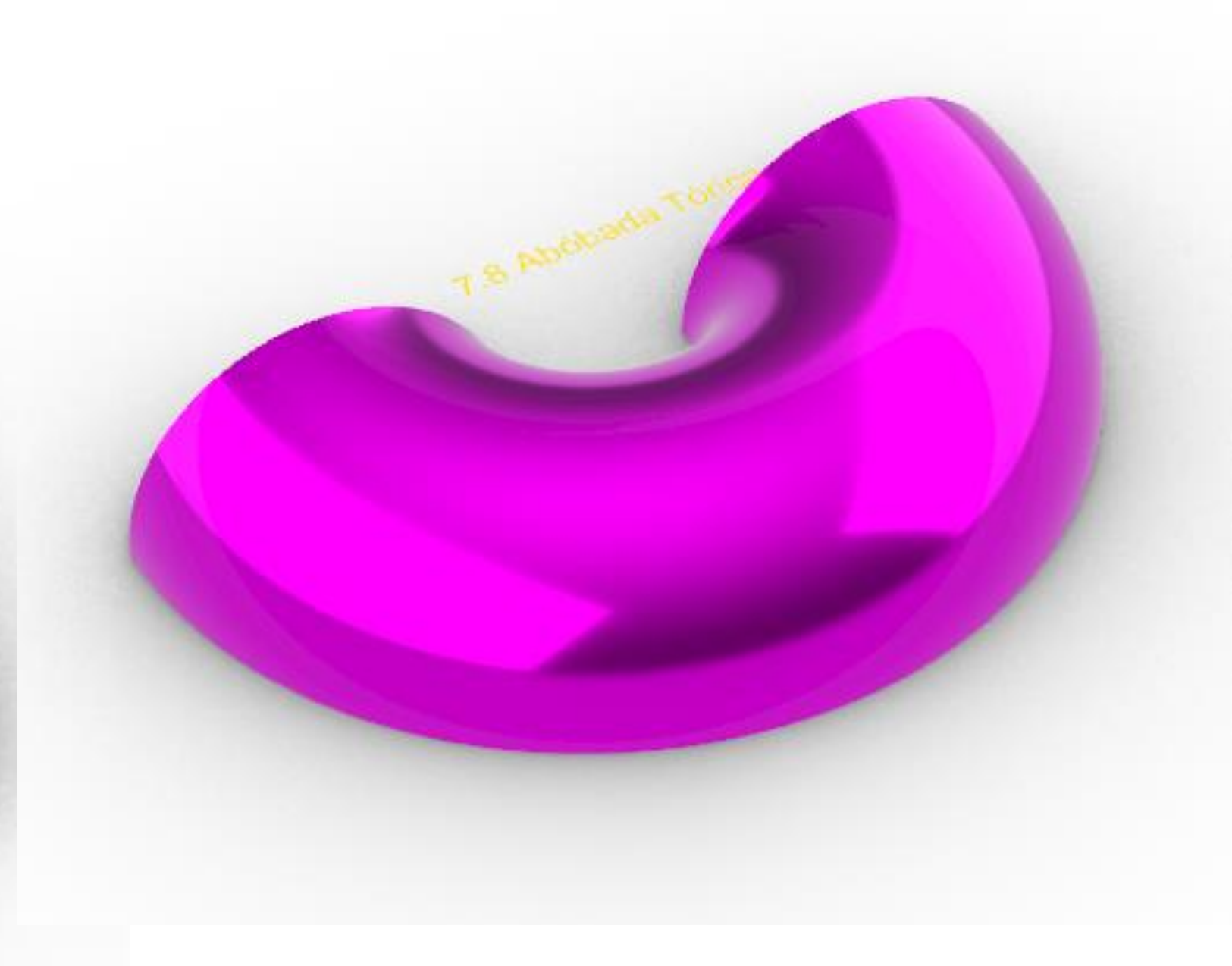
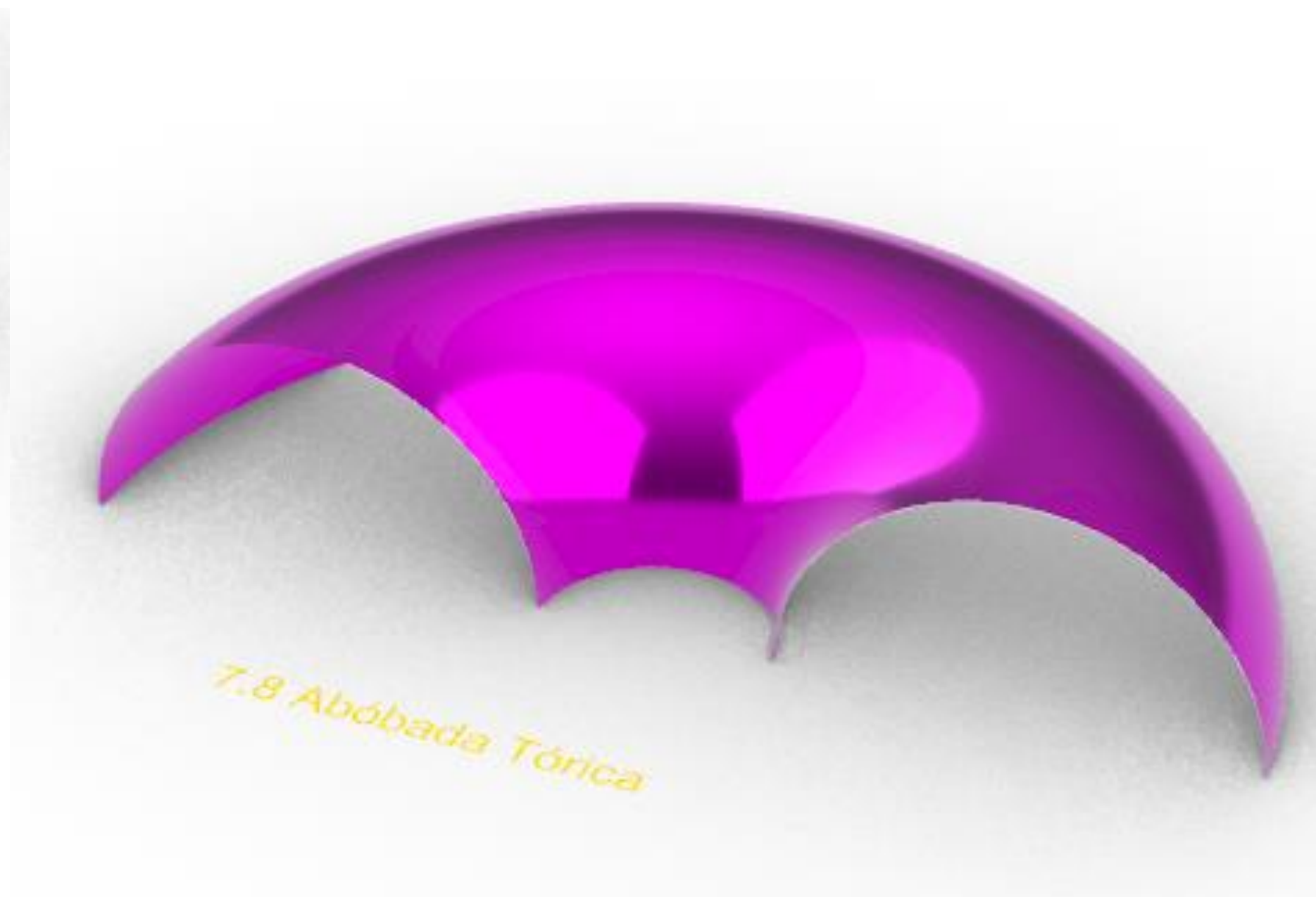

Exerc.9.8 Abobada Tórica

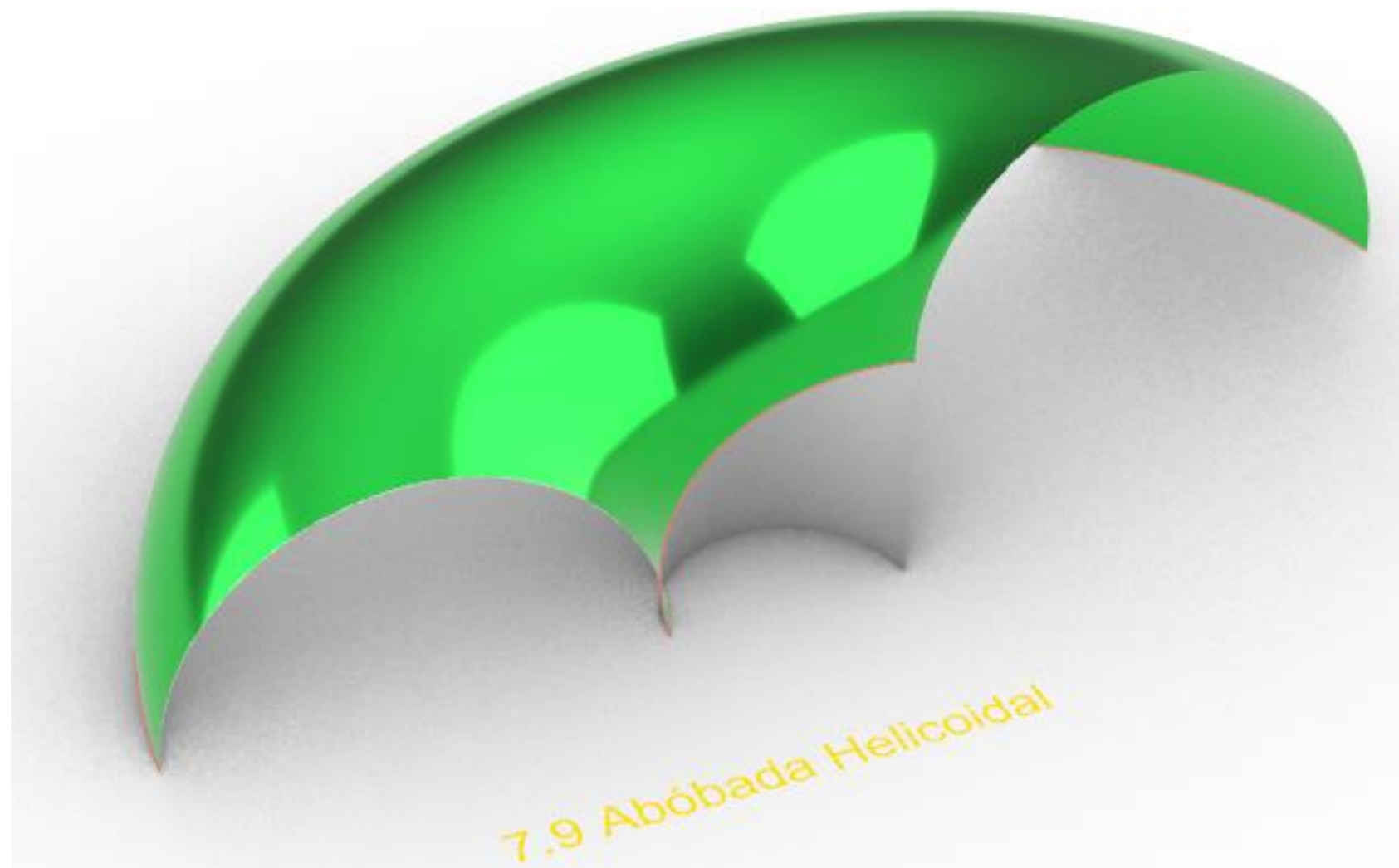
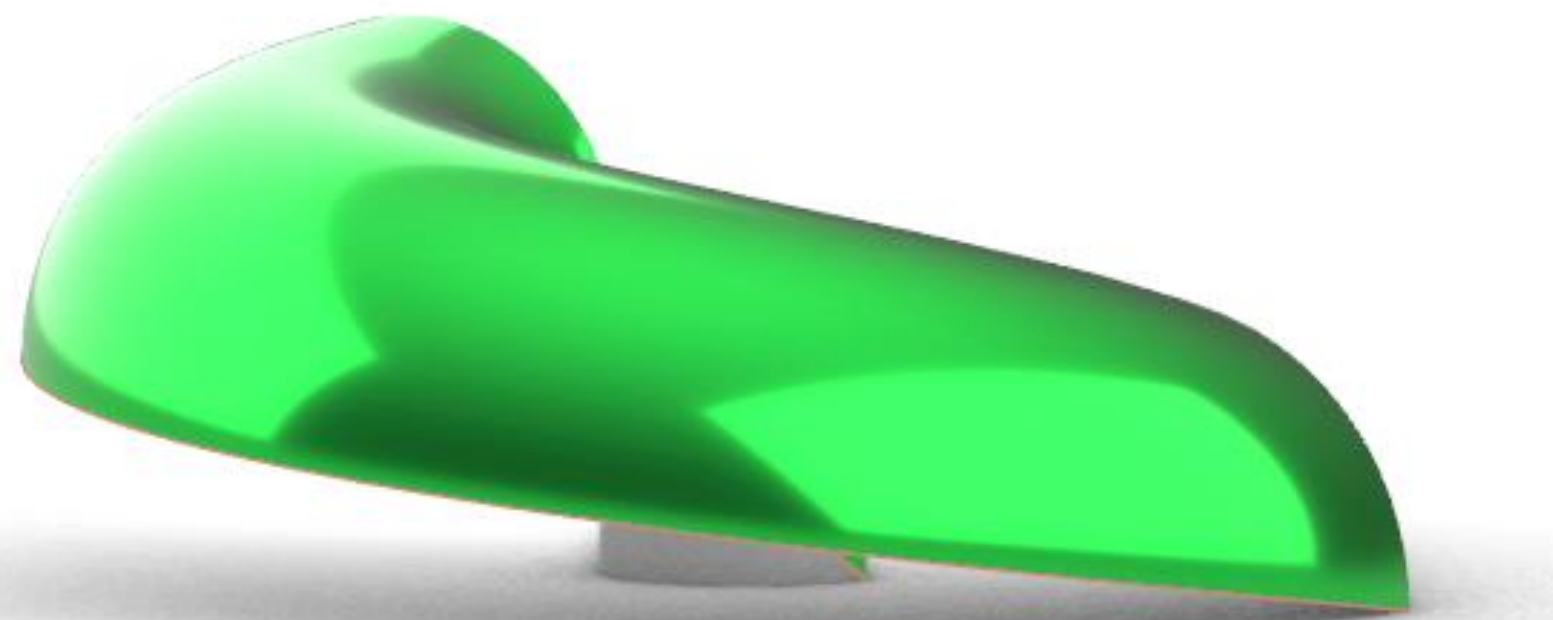

Exerc.9.9 Abobada Helicoidal